

| INSTALLATION & OPERATION MANUAL

MEF 2100 Inline Electromagnetic Flow Meter



MIAL[®]
INSTRUMENTS PVT.LTD.
Measuring & Beyond

www.mialinstruments.com

MEF 2100

Inline Electromagnetic Flow Meter

Preface

- Thank you for purchasing our product.
- This manual is about the various functions of the product, wiring methods, setting methods, operating methods, troubleshooting methods, etc.
- Please read this manual carefully before operation, use this product correctly to avoid unnecessary losses due to incorrect operation.
- After you finish reading, please keep it in a place where it can be easily accessed at any time for reference during operation.



NOTE!

Modification of this manual's contents will not be notified as a result of some factors, such as function upgrading. We try our best to guarantee that the manual content is accurate, if you find something wrong or incorrect, please contact us. The content of this manual is strictly prohibited from reprinting or copying.

About this manual

- Please submit this manual to the operator for reading.
- Please read the operation manual carefully before installing the instrument. On the precondition of full understanding.
- This manual only describes the functions of the product. The MIAL Instruments pvt.ltd. does not guarantee that the product will be suitable for a particular application.

Warnings and symbols used



HAZARD!

If not taken with appropriate precautions, will result in serious personal injury, product damage or major property damage.



WARNING!

Pay special attention to the important information linked to product or particular part in the operation Manual



CAUTION!

Disregarding these instructions can result in damage to the device or to parts of the operator's plant.



INFORMATION!

These instructions contain important information for the handling of the device.



Table of Contents

PREFACE	2
ABOUT THIS MANUAL	2
1. INTRODUCTION	5
1.1 PURPOSE OF THE MANUAL	5
1.2 OPERATING PRINCIPLE	6
1.3 TECHNICAL SPECIFICATIONS	7
1.4 SUPPLEMENTARY ACCESSORIES THAT COULD BE NEEDED	9
1.4.1 GROUNDING RINGS	9
2. DEVICE DESCRIPTION	10
2.1 SCOPE OF DELIVERY	10
2.2 NAMEPLATES	11
3. INSTALLATION	12
3.1 SITE SELECTION	12
3.1.1 BASIC RECOMMENDATIONS.....	12
3.1.2 FLOW DIRECTION.....	12
3.1.3 INSTALLATION OF REMOTE MOUNT TRANSMITTER.....	12
3.1.4 STRAIGHT LENGTH REQUIREMENT.....	13
3.2 MECHANICAL INSTALLATION	15
3.2.1 STANDARD TRANSMITTER DIMENSIONS	15
3.2.2 INSTALLATION DRAWINGS FOR NON-CONDUCTIVE PIPE	16
3.2.2 FLOW SENSOR DIMENSIONS	17
3.2.3 INSTALLATION.....	18
4 ELECTRICAL CONNECTIONS	19
4.1 SAFETY INSTRUCTION	19
4.2 CONNECT SIGNAL & MAGNETIC FIELD CURRENT CABLE	23
4.3 REMOTE TYPE WIRING INSTRUCTION	20
4.4 MEF 2100 WIRING DIAGRAM	20
4.5 MEF 2100 MODBUS REGISTER DETAILS.....	21
4.6 CONNECTED TO POWER	21
4.7 LAYING ELECTRICAL CABLES CORRECTLY	22
4.8 EARTH CONNECTION	22
4.9 CHARACTERISTIC AND CONNECTION OF CABLE	23
4.9.1 EXCITING CURRENT CABLE.....	23
4.9.2 FLUX SIGNAL LINE	23
4.9.3 OUTPUT AND POWER LINE	23



4.9.4 GROUNDING.....	24
4.10 DIGITAL OUTPUT AND CALCULATIONS.....	24
4.10.1 FREQUENCY OUTPUT	24
4.10.2 PULSE OUTPUT MODE	25
4.10.3 THE CONNECTION OF DIGITAL OUTPUT	25
4.10.4 THE CONNECTION OF DIGITAL VOLTAGE OUTPUT.....	25
4.10.5 DIGITAL OUTPUT CONNECT ELECTRICITY COUPLING (PLC ETC.)	26
4.10.6 DIGITAL OUTPUT CONNECT RELAY.....	26
4.11 ANALOG OUTPUT AND CALCULATIONS.....	26
4.11.1 ANALOG OUTPUT	25
4.11.2 ANALOG OUTPUT ADJUSTMENTS	25
5 START UP.....	28
5.1 SWITCHING ON THE POWER.....	28
5.2 OPERATION	28
KEY AND DISPLAY.....	28
5.3 PARAMETERS AND SETTING	28
5.4 REMOTE TYPE LCD DISPLAY	29
5.5 SETTING PARAMETERS.....	29
5.6 KEYS' FUNCTION IN SELF-DIAGNOSIS WAY.....	29
5.7 FUNCTION KEYS FOR PARAMETERS SETTING	29
5.8 FUNCTION KEYS FOR SETTING PARAMETERS.....	30
5.9 SETTING PARAMETERS IN MENU.....	30
5.10 PROGRAM PARAMETERS	33
5.11 ALARM INFORMATION	38
APPENDIX 1 : ON/OFF SWITCH DIAGRAM.....	39
APPENDIX 2: FLOW COEFFICIENT MODIFICATION RECORD	40
APPENDIX 3 : LIGHTNING PROTECTION NOTES.....	41
APPENDIX 4: FLOW RANGE AND VELOCITY TABLE	42

1. INTRODUCTION

1.1 PURPOSE OF THE MANUAL

Overview:

Welcome to the user manual for the Mial MEF 2100 - Electromagnetic Flowmeter. This comprehensive guide is designed to assist operators, maintenance personnel, and system integrators in understanding, installing, operating, and maintaining the Mial MEF 2100 - Electromagnetic flow meter effectively.

Objectives:

Clarification of Functionality: This manual aims to provide a clear understanding of the principles and functionality of the Mial MEF 2100 - Electromagnetic Flowmeter. Users will gain insights into its design, components, and how it precisely measures fluid flow.

Guidance for Installation:

Step-by-step instructions and considerations for proper installation are provided to ensure optimal performance. Safety precautions are emphasized to create a secure working environment.

Training and Familiarization:

Users will be guided through the features, controls, and indicators of the flow meter, facilitating efficient operation. This section aims to serve as a valuable training resource for users at various experience levels.

Maintenance and Troubleshooting Assistance:

Learn about routine maintenance procedures and effective troubleshooting techniques. This manual empowers users to address common issues and perform regular maintenance to enhance the longevity of the Mial MEF 2100 - Electromagnetic Flowmeter.

Intended Audience:

This manual is intended for operators, maintenance personnel, and system integrators involved in the installation, operation, and maintenance of the Mial MEF 2100 - Electromagnetic Flowmeter. It is suitable for both novice users seeking basic guidance and experienced professionals looking for specific details.

Important Notes:

Please read through the manual carefully, adhering to safety guidelines and following instructions precisely. If any uncertainties arise during the installation, operation, or maintenance processes, seek assistance from qualified personnel or our customer service / support team.

Reference to Other Documentation:

Refer to the accompanying technical specifications document for in-depth details about the Mial MEF 2100 - Electromagnetic Flowmeter. Additional resources can be found on our website.

Intended use



CAUTION!

Responsibility for the use of the measuring devices with regard to suitability, intended use and corrosion resistance of the used materials against the measured fluid lies solely with the operator.



INFORMATION!

The manufacturer is not liable for any damage resulting from improper use or use for other than the intended purpose

Certification



The manufacturer certifies successful testing of the product by applying the CE marking



The manufacturer certifies successful testing of the product by applying the ISO marking

1.2 OPERATING PRINCIPLE

The Electromagnetic flow meter operates by inducing a magnetic field across a pipe through which a conductive fluid flows. Coils or electrodes generate the magnetic field, and as the fluid moves through, it cuts across the field, adhering to Faraday's Law of Electromagnetic induction. This results in the generation of an induced voltage in the fluid, which is picked up by electrodes on the opposite sides of Flow tube. The magnitude of this voltage is directly proportional to the flow rate of the fluid. The meter's electronics process these voltage signals to calculate and display the flow rate. Notably effective for measuring conductive fluids like water, Electromagnetic flow meters are particularly valuable for applications involving abrasive or corrosive substances. The accuracy of the measurements is contingent on factors such as the uniformity of the magnetic field and the conductivity of the fluid being measured. Users should refer to the manufacturer's manual for precise instructions on installation and calibration.

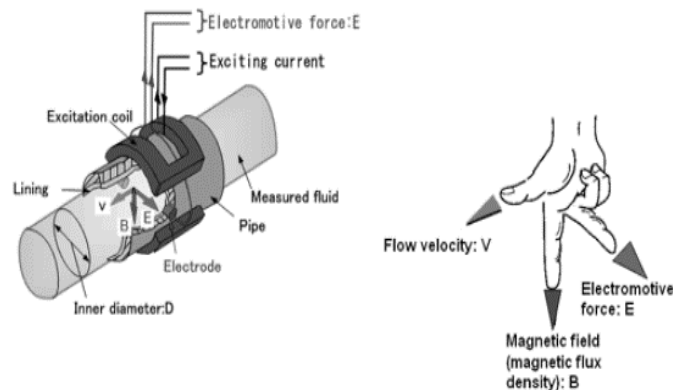

1.3 TECHNICAL SPECIFICATIONS*

Operation and performance

Flow measurement Technology

The flow measurement technology of electromagnetic flow meters is based on Faraday's law of electromagnetic induction, where the induced voltage across electrodes is proportional to the fluid velocity, allowing for accurate flow measurement.

Fluid types

Electrically conductive fluids such as water

(Hot Water, Chilled Water, Condensate Water, Domestic Water, Waste Water etc.)

Conductivity

>5us/cm

Pipe sizes

15 MM –2000 MM

Pipe materials

Metallic and Non Metallic pipes.

Flow accuracy

Standard :±0.5%

Optional: ±0.2%

Achievable with process calibration

Repeatability

Flow:±0.17%

BTU: ±0.27%

Linearity

Standard: ±0.5%

Optional: ±0.2%

Measuring range

Max 0–40 ft/s

Measurement parameters

Flow Meter– Instantaneous flow rate, totalized flow

Certification

Factory calibration certification, CE, ISO

Electronics

Enclosures

Aluminium

Use weather proof enclosure while installing the transmitter outside

Enclosure IP rating

IP 65

EEPROM Memory

Yes

Power supply

24 VDC/2A

Use 2-amp SMPS when employing AC power

Ambient temperature

32°F to 140°F (0°C to 60°C)

Relative Humidity

5– 95% RH

Standard Analog outputs

Flow meter– 4–20 mA

Output programmed for current flow rate. 500 Ω maximum load,

Pulse Outputs

Flow Meter– Pulse

Programmed for Flow Consumption , Contact pulse Duration –0.1~300 ms

Network Connection

Modbus RTU RS485

Cable

10M

Flow tube specification

Coil material

Pure Copper

99% copper (Cu) content, excellent electrical conductivity, corrosion resistance

Process connections

Standard: ANSI 150 flanges

Optional: ANSI 300 flanges

Operating temperature

14°F to 248°F (–10 °C to 120 °C)

Nominal Pressure

Standard: 1.6 Mpa

Optional: 2.5 Mpa, 4.0 Mpa, 5Mpa

Flow Tube

SS 304

Electrode Material

Standard: SS 316L

Optional: Hastelloy, Titanium, Tantalum,

Liner

Standard: PTFE



Optional: Ebonite, Polyebonite, Polyurethane, PFA

Flange

Standard: Carbon Steel

Optional: Stainles steel

Mountings

Flanged flow tube

IP rating

Flow tube : IP68

Transmitter : IP 65

Energy measurement

Temperature sensor

PT1000

22°F to 392°F (-30°C-200°C)

Wetted insertion thermowell

Cable

10 M

**Specifications are subject to change without prior notice.*



1.4 SUPPLEMENTARY ACCESSORIES THAT COULD BE NEEDED

1.4.1 GROUNDING RINGS

Grounding rings may be needed when meters are installed in non-metallic pipes or lined pipes. Placing these rings before and after the meter helps to reduce electrical interference, allowing the meter to function accurately. Mial Instruments provides these grounding rings as an optional accessories.

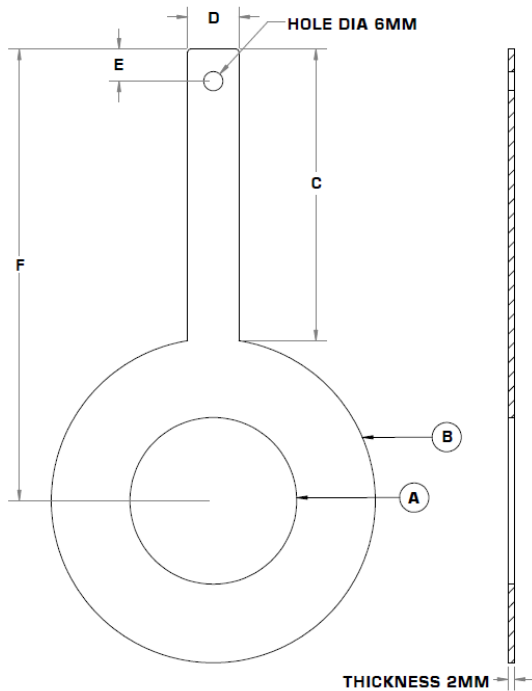







GROUNDING RING SIZES						
ALL DIAMENSIONS ARE FOR FLANGE 150#						
SIZE (MM)	A (ID)	B (OD)	C	D	E	F
15	18	40	50	16	10	70
20	23	42	60	16	10	81
25	26	62	60	16	10	91
32	32	63	60	16	10	91.5
40	40	80	60	16	10	100
50	52	101	60	16	10	110.5
65	63	104	70	20	10	122
80	80	130	70	20	10	135
100	104	158	75	20	10	154
125	130	187	75	20	10	168.5
150	158	217	75	20	10	183.5
200	206	267	75	20	10	208.5
250	260	328	75	20	10	239
300	310	375	85	20	10	272.5

ALL DIAMENSIONS IN MM



2 DEVICE DESCRIPTION

2.1 SCOPE OF DELIVERY

-  **INFORMATION!**
Do a check of the packing list to make sure that you have all the elements given in the order
-  **INFORMATION!**
Inspect the packaging carefully for damages or signs of rough handling. Report damage to the carrier and to the local office of the manufacturer.
-  **INFORMATION!**
The field device will arrive in one standard cartons. The standard carton contains one small corrugated box containing Transmitter Unit. Also, the standard carton box contains Flow Tube ,Product documentation, Test Certificates, Allen key & bolts sets
-  **INFORMATION**
The MEF 2100 transmitters and sensor bodies are components of a uniquely calibrated system and must be installed together as per the serial number. Mixing components from other systems will result in significant calibration errors.The transmitter serial number can be found on the sticker on the side of the electronics enclosure, and the sensor serial number is located on the sticker on the sensor body.
-  **INFORMATION!**
Mandatory to loop between the grounding rings by using a proper wire and connect the end of the wire to a ground source in the DDC panel.
-  **INFORMATION!**
Grounding Ring will be provided only if the pipe material is Non-Metallic & will be charged additional

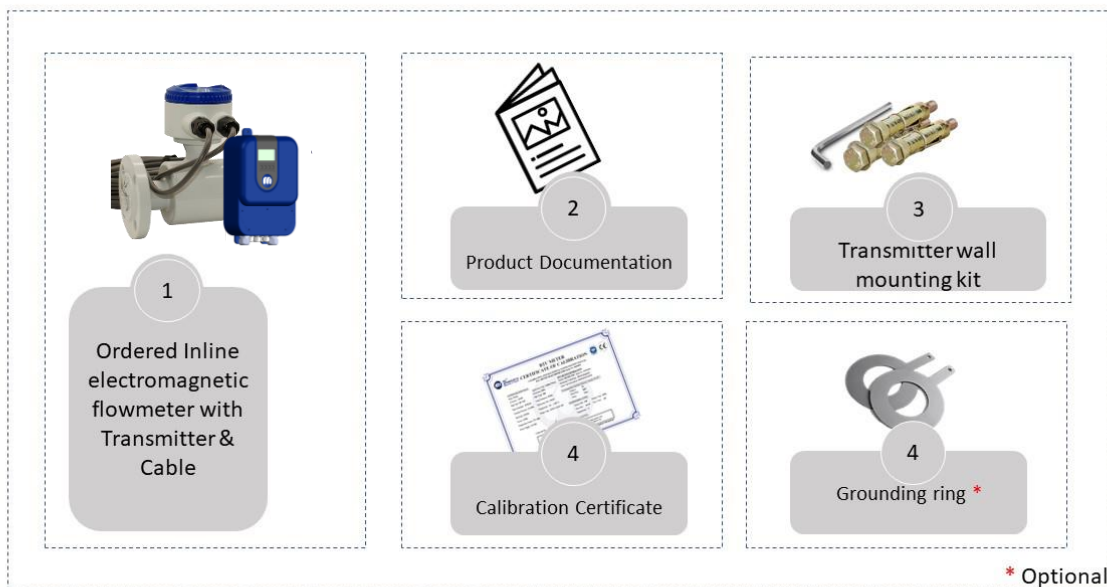



2.4 NAMEPLATES



INFORMATION!

Look at the device nameplate to ensure that the device is delivered according to your order. Check for the correct supply voltage printed on the nameplate

NAMEPLATE FOR THE TRANSMITTER

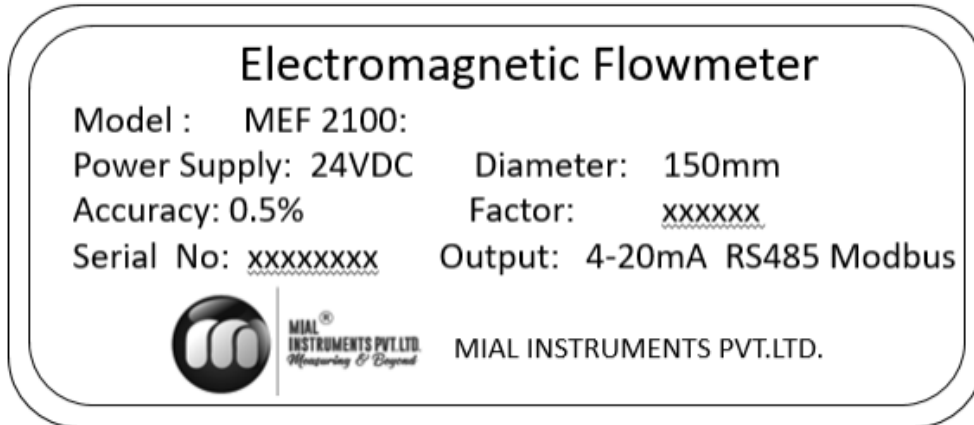

NAMEPLATE FOR THE FLOW TUBE





3 INSTALLATION

3.1 SITE SELECTION

When selecting a site for a flow meter installation, prioritize accessibility for installation and maintenance. Consider environmental factors like temperature and humidity as per guidelines. Ensure the flow profile is stable and the pipe is in good condition. Safety and ease of access for personnel should also be taken into account to optimize meter performance and longevity.

3.1.1 BASIC RECOMMENDATIONS

In general guidelines, it's recommended to find a location where the pipe has the longest straight segment with a clear run. This ensures smooth laminar flow of the fluid through the meter, which is crucial for accurate measurement. A longer clear run of pipe minimizes disturbances and turbulence that could affect the meter's performance. This approach helps optimize the meter's accuracy and reliability by providing a stable flow profile for measurement.

3.1.2 FLOW DIRECTION

The Mial MEF 2100 Flow meter should be installed ensuring the arrow indicated on the meter points in the direction of flow. When correctly installed, as illustrated, the arrowhead should align with the flow direction. The transmitter display will indicate positive values corresponding to the flow direction indicated by the arrow. If the fluid flows in the opposite direction to the arrow, the display will show negative readings reflecting the reverse flow direction.

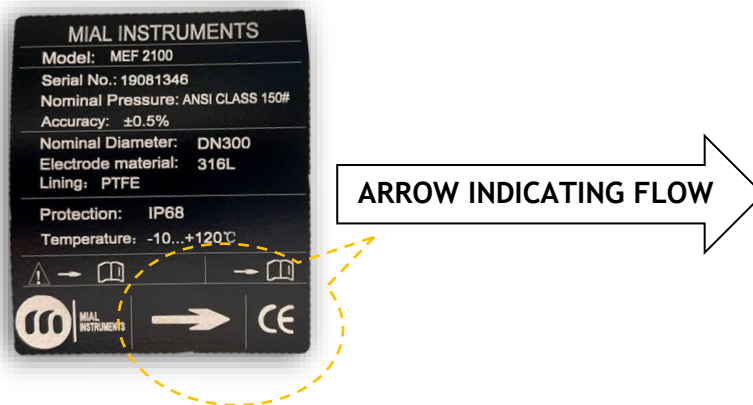

3.1.3 INSTALLATION OF REMOTE MOUNT TRANSMITTER

Installing a remote mount transmitter involves placing the unit at a distance where the display is easily visible to the user. It should be positioned away from equipment that may generate electrical interference. The standard cable length from the flow tube to the transmitter becomes 10 meters and it can't be cut or extendable at the site. For the outdoor installation mandatory to provide a non-metallic FRP/GRP enclosure



3.1.4 STRAIGHT LENGTH REQUIREMENT

The diagrams below demonstrate the minimum straight length necessary to ensure accurate readings from the flow meter. Having additional straight length beyond this minimum requirement offers additional advantages, such as enhanced measurement precision and reduced potential for turbulence or flow disturbances that could affect meter performance. Therefore, maximizing the straight length of the pipe where the flow meter is installed can contribute to optimizing the overall effectiveness and reliability of the measurement process.

SLOP & VERTICAL LINES

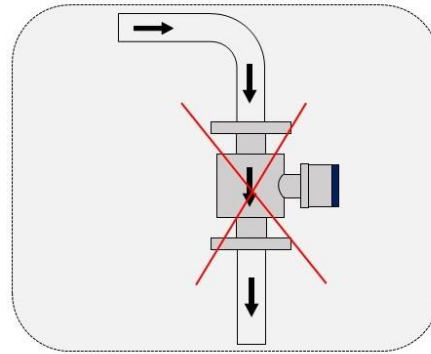
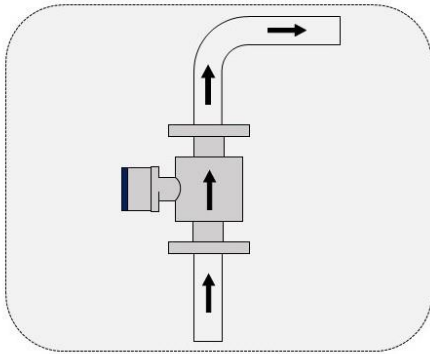

Install at the rising direction

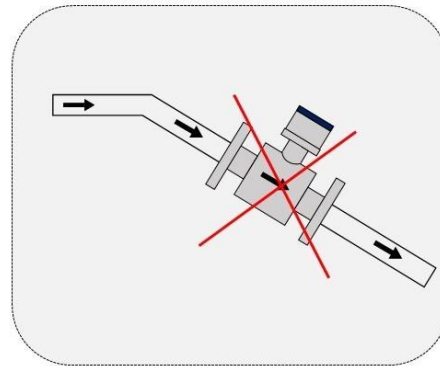
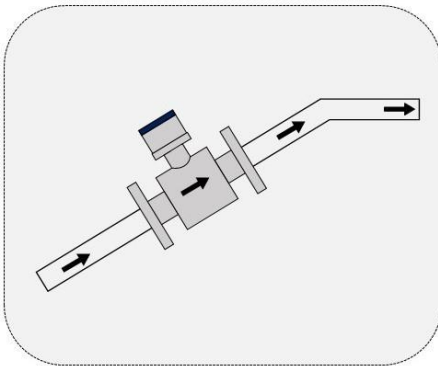

OPEN FEED OR DISCHARGE

Install at the rising direction

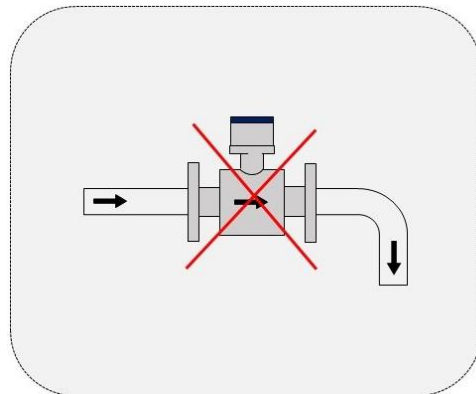
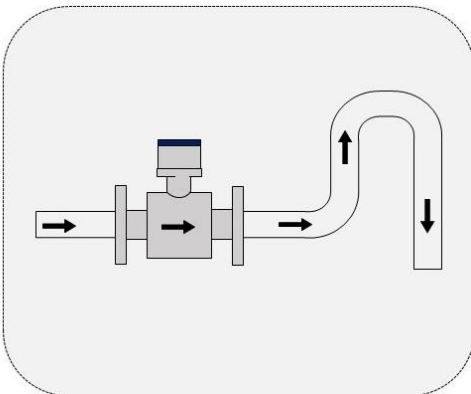

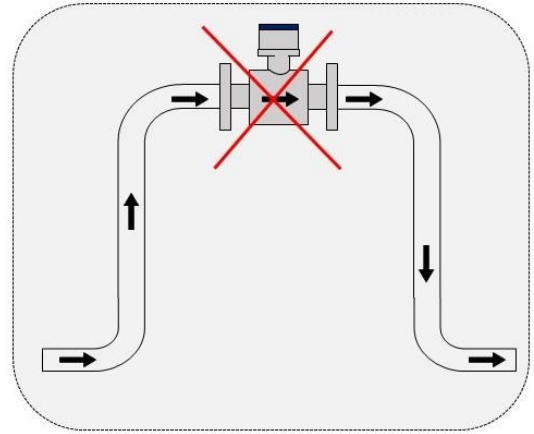
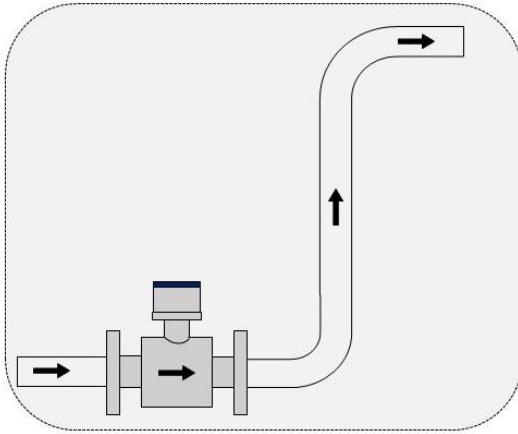

Install at the lowest point when used in open drain pipe

CONTROL VALVE

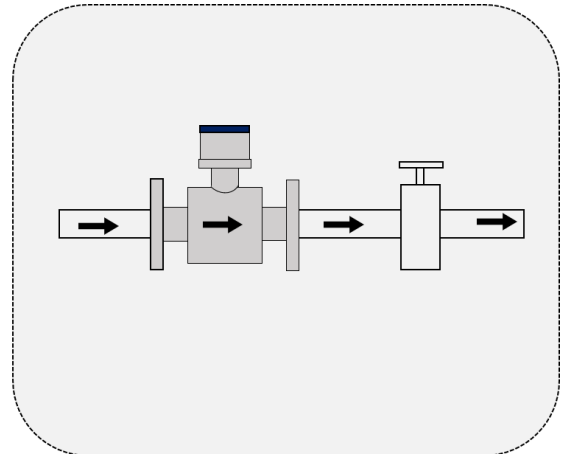
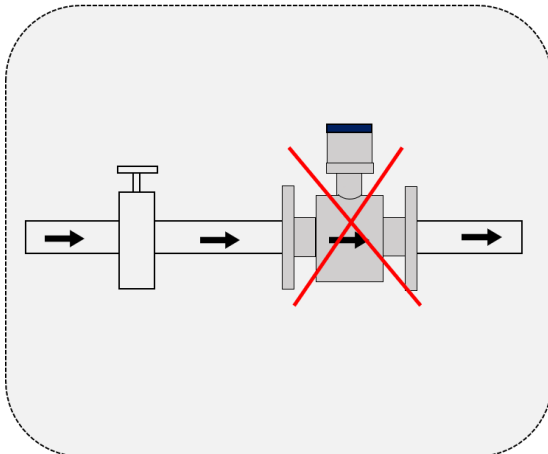

Don't install it at the exit of the valve, install it at the entrance of the valve

POSITION OF PUMP

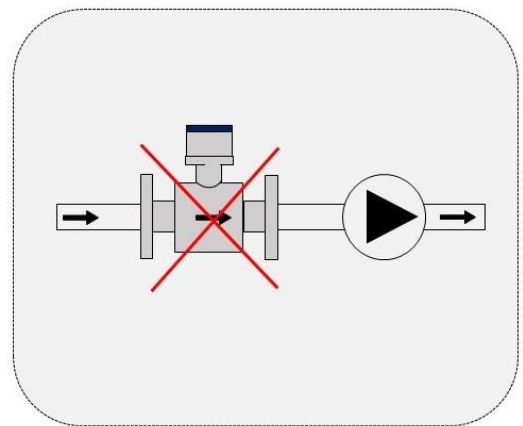
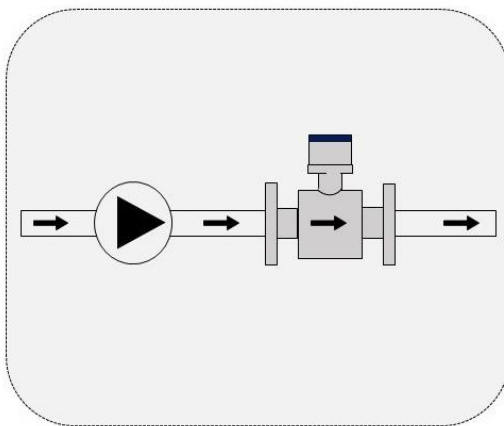

Don't install it at the entrance of the pump, install it at the exit of the pump



DOWN GOING PIPELINE OVER 5 M /16 FT LENGTH

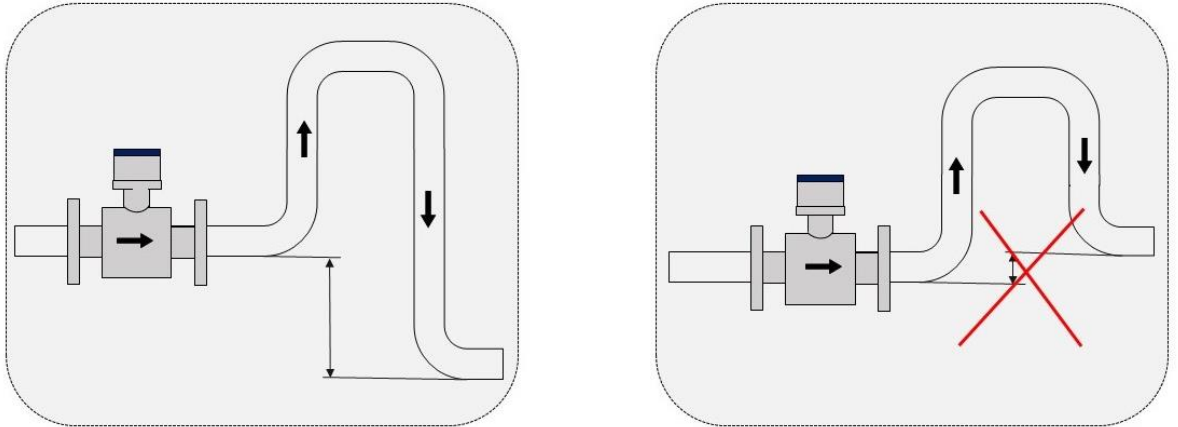

The downstream of flow meter when the drop is more than 5 m

3.2 MECHANICAL INSTALLATION



IMPORTANT NOTE!

MEF 2100 transmitters and sensor bodies are two parts of one uniquely calibrated system and must be installed together as per the serial Number . Mixing components from other systems will result in significant calibration errors.

3.2.1 STANDARD TRANSMITTER DIMENSIONS

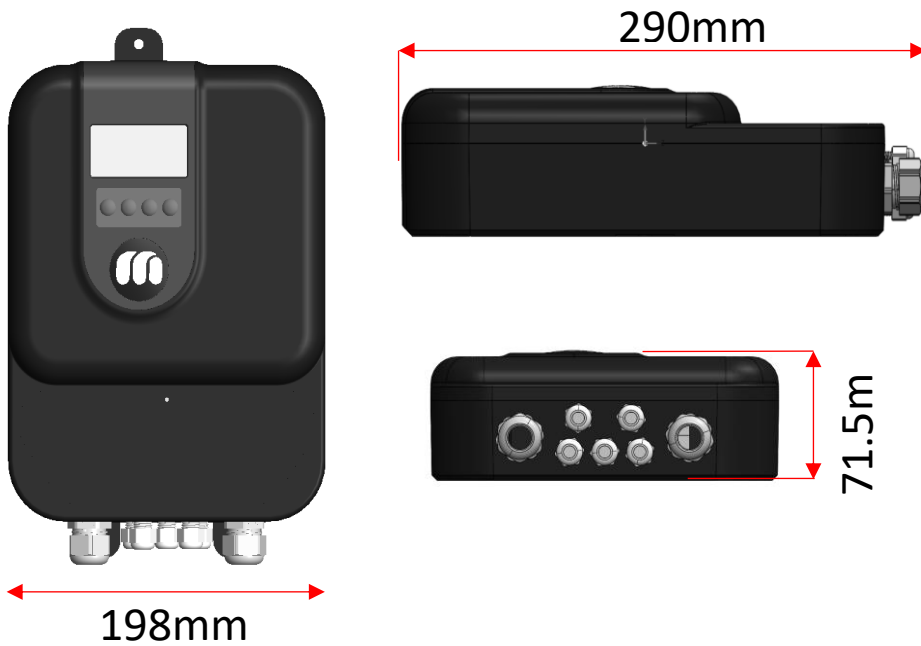



3.2.2 INSTALLATION DRAWINGS FOR NON-CONDUCTIVE PIPE

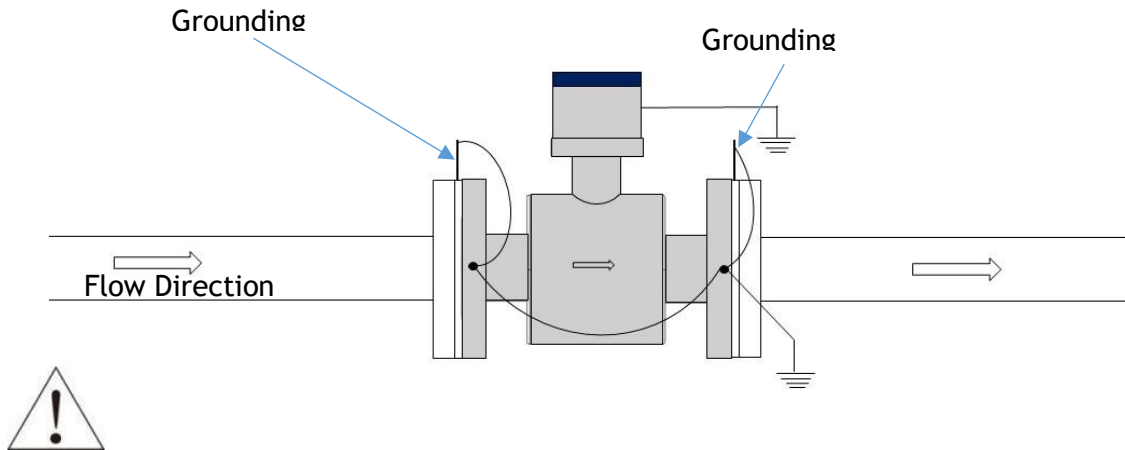

CAUTION

Make sure to connect the earth wires like the picture shows. If you don't, the meter might not work right.

INSTALLATION STEPS

WARNING!

Only trained workers should install this product, and they must follow all the rules for buildings.

1. Clean all flange surfaces well, making sure to remove any old gasket material or adhesive
2. Check all flange surfaces for any bending, dents, or other problems that might stop a good seal.
3. Use new bolts, nuts, and strong washers. Before putting them in, apply lubricant to the bolt threads, nuts, washer sides, and under the bolt head. This helps spread pressure evenly on the seal. Be careful not to get any lubricant on the liner or gasket.
4. Place the new gasket in the middle of the liner surface. Make sure the gasket doesn't stick out into where the liquid flows.
5. Use a torque wrench to tighten the bolts in three stages: first 30%, then 60%, and finally 100%. Tighten them in a repeating pattern.



3.2.3 FLOW SENSOR DIMENSIONS

ANSI CLASS 150 FLANGED SENSOR OVERALL DIMENSION

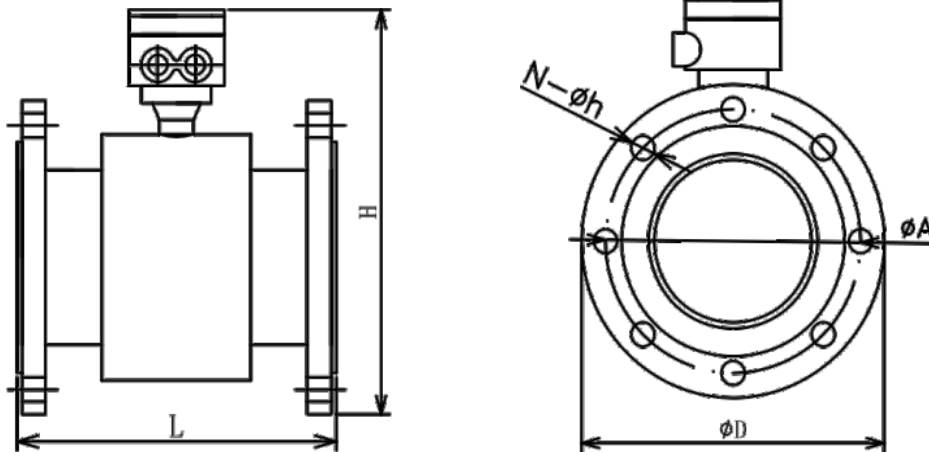

PIPE SIZE	L	D	A	N- Ø h	H
DN 15	200	89	60.5	4-Ø15.7	217
DN20	200	99	69.9	4-Ø15.7	217
DN25	200	108	79.3	4-Ø15.7	220
DN32	200	118	88.9	4-Ø15.7	230
DN40	200	127	98.6	4-Ø15.7	240
DN50	200	152	120.7	4-Ø19.1	255
DN65	200	178	139.7	4-Ø19.1	280
DN80	200	190	152.4	4-Ø19.1	285
DN100	250	229	190.5	8-Ø19.1	315
DN125	250	254	215.9	8-Ø22.4	340
DN150	300	280	241.3	8-Ø22.4	370
DN200	350	343	298.5	8-Ø22.4	430
DN250	450	406	362	12-Ø25.4	495
DN300	500	483	432	12-Ø25.4	558
DN350	550	533	476.3	12-Ø28.4	608
DN400	600	597	540	16-Ø28.4	674
DN450	600	635	578	16-Ø32	718
DN500	600	699	635	20-Ø32	775



3.2.4 INSTALLATION

Installation of this product should be carried out by qualified professionals, ensuring compliance with all relevant local, state, and federal building codes. Begin by thoroughly cleaning all flange surfaces to remove any old gasket material and adhesive residue. Inspect the flange surfaces for any warping, pitting, or imperfections that could affect the seal. Use new bolts, nuts, and hardened washers, and lubricate them to ensure even stress distribution during installation. Be careful to avoid getting any lubricant on the liner .

INSTALLATION DIAGRAM

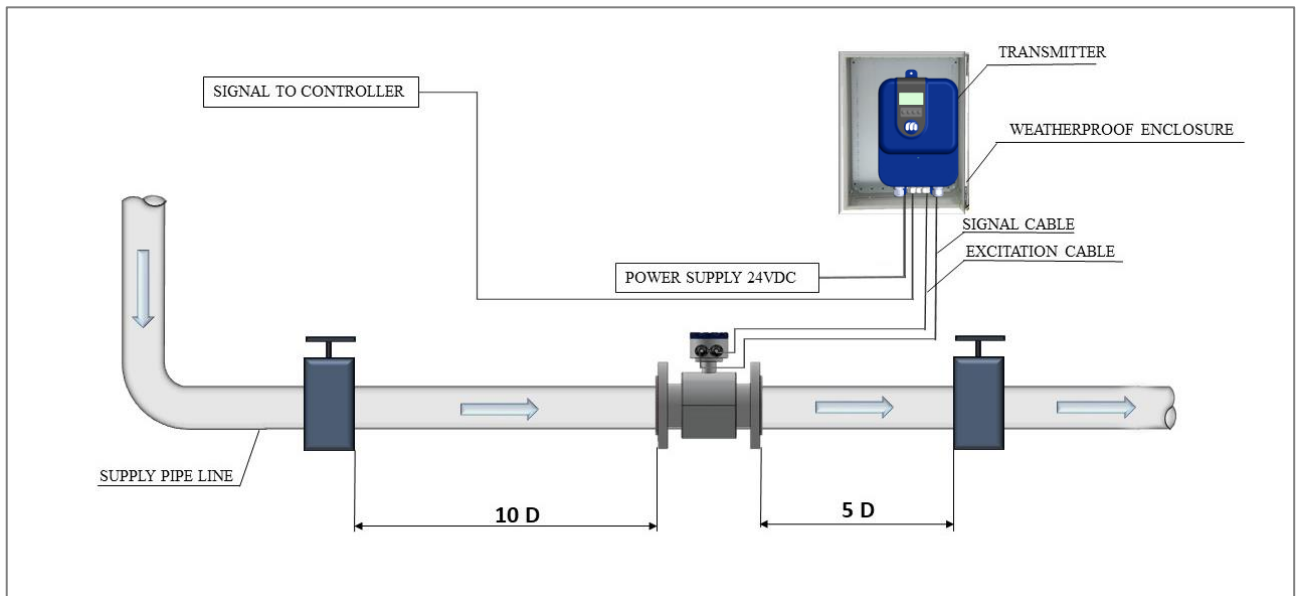

To ensure electromagnetic water meters work correctly, install the flow sensor head at the top of a horizontal pipe at the 12 o'clock position. The pipeline must be pressurized and filled entirely with clean water, without any air or particles. Air and particles act as insulators, disrupting the meters' electromagnetic induction and impairing their function. For vertical pipes, install the meter so water flows from bottom to top for optimal performance.



4 ELECTRICAL CONNECTIONS

4.1 SAFETY INSTRUCTIONS



DANGER!

Only when power is switched off, can we do all the work about electrical connections. Please pay all attention to the power supply on the name plate!



DANGER!

Observe the national regulations for electrical installations!



DANGER!

For devices used in hazardous areas, additional safety notes apply; please refer to the Ex documentation.



WARNING!

Observe without fail the local occupational health and safety regulations. Any work done on the electrical components of the measuring device may only be carried out by properly trained specialists.



INFORMATION!

Look at the device nameplate to ensure that the device is delivered according to your order. Check for the correct supply voltage printed on the nameplate.



INFORMATION!

Connect the cable on connector with similar numeral marking

4.2 CONNECT SIGNAL AND MAGNETIC FIELD CURRENT CABLE



Danger !

Only when power is cut off can you connect signal and magnetic field current conductor.



Danger !

The equipment must be grounded in accordance with regulations so as to protect the operator from electrical shock.



Danger !

In case that equipment be used in explosion danger areas, special notes are given to explosion-proof instructions for safety tips.



Warning !

Please strictly observe local occupational health and safety regulations. Only those who have got properly trained are allowed to operate on the electrical equipment



4.3 REMOTE TYPE WIRING INSTRUCTION

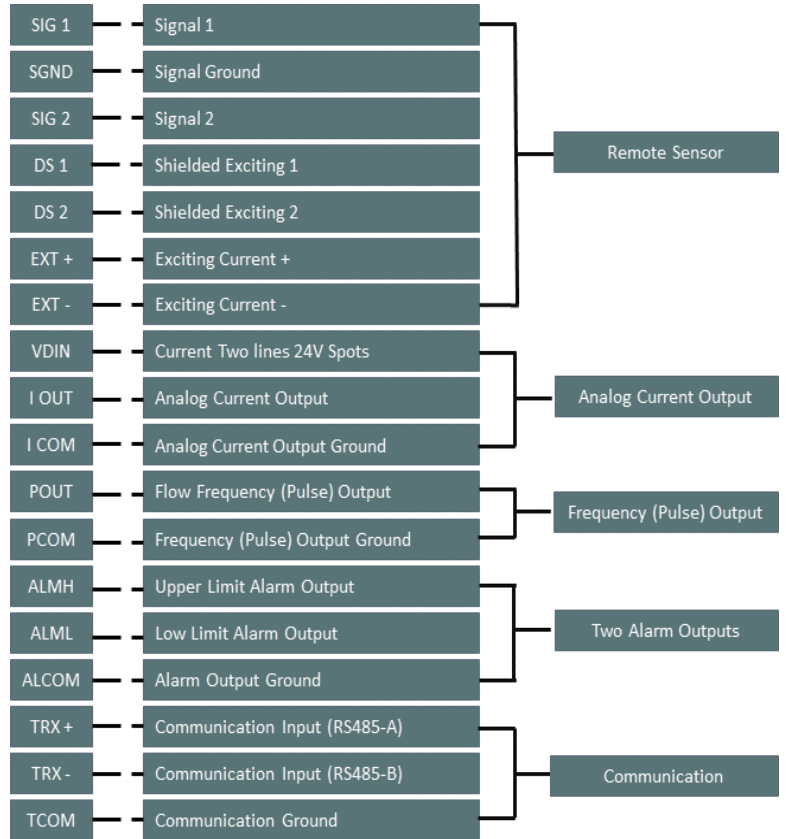
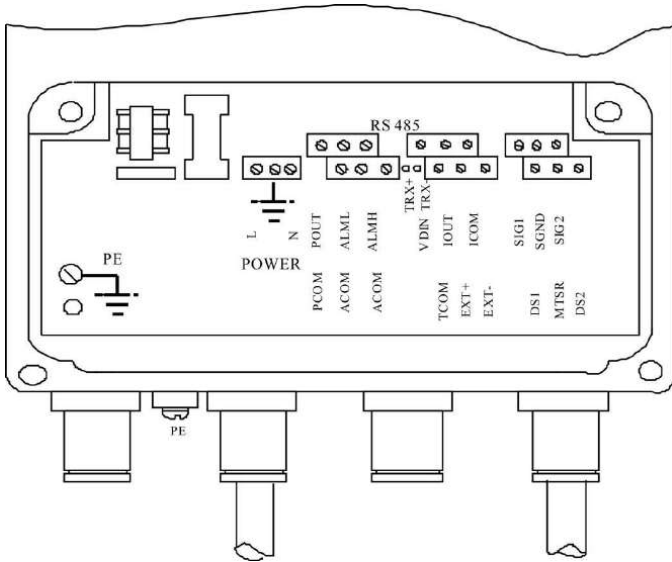

4.4 MEF 2100 WIRING DIAGRAM AND MODBUS REGISTER DETAILS

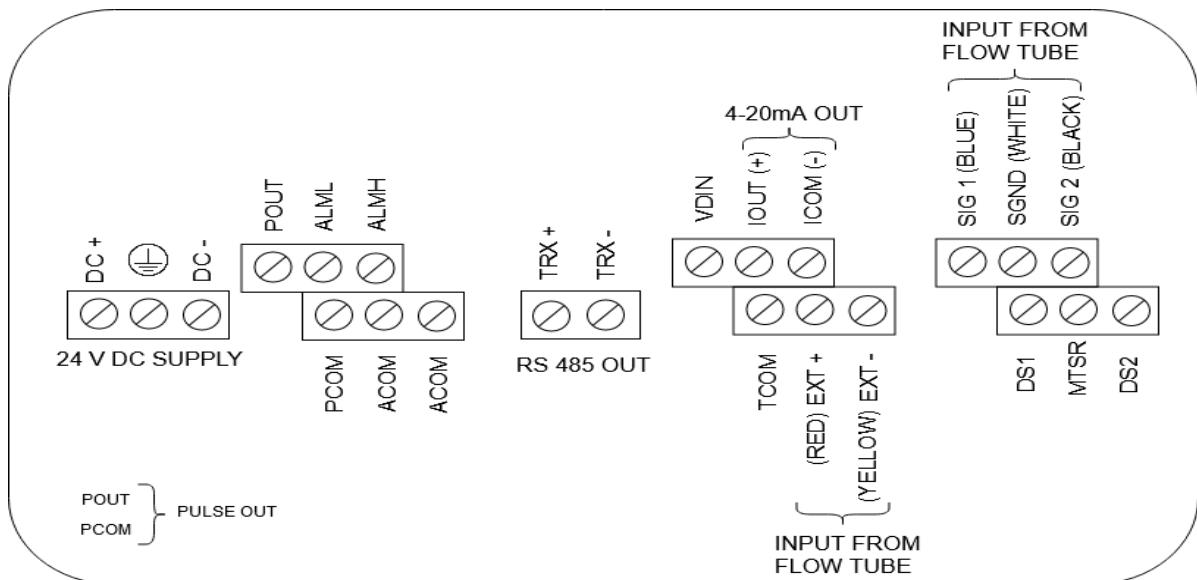



4.5 MEF 2100 MODBUS CONFIGURATION DETAILS OF FLOW METER TO BMS

FUNCTION CODE	DETAILS	REGISTER ADDRESS	MODBUS REGISTER	REGISTER TYPE
04 : INPUT REGISTER	FLOW RATE	4113	34113	SWAPPED F.P
	FLOW TOTAL	4121, 4122*	34121, 34122	DECIMAL
	MTP (EMPTINESS OF PIPE) %	4119	34119	DECIMAL/ INTEGER
	FQP (FLOW PERCENTAGE)%	4117	34117	DECIMAL/ INTEGER
	FLS (FLOW SPEED) M/S	4115	34115	DECIMAL/ INTEGER

MEF 2100 (Remote) Flow Meter MODBUS Configuration Details

*N.B:- $Flow\ Total = 65535 * [34121] + [34122]$
 {Were; 34121 - High position registers.
 34122 - Low position registers.}

Note: If your BMS register address starts from '0', please decrement '1' value from every register. Example: Supply temperature register is 34141 then it should be configured as 34140.

4.6 CONNECTED TO POWER



It is mandatory to provide an individual 24 VDC, SMPS (Switch Mode Power Supply) for energizing the flow meters. Additionally, it is essential to pull three-core wires (DC+, DC-, and ground) for the 24 VDC input power supply. As these are electromagnetic flow meters, a proper input power supply with an appropriate ground is crucial for their correct operations



Danger !
 The equipment must be grounded in accordance with regulations so as to protect the operator from electrical shock.



Don't use bolts that hold the pipes together to make electrical connections. These bolts might not connect well because of paint or grease. Instead, use the special earth connections on the flange.



4.7 LAYING ELECTRICAL CABLES CORRECTLY

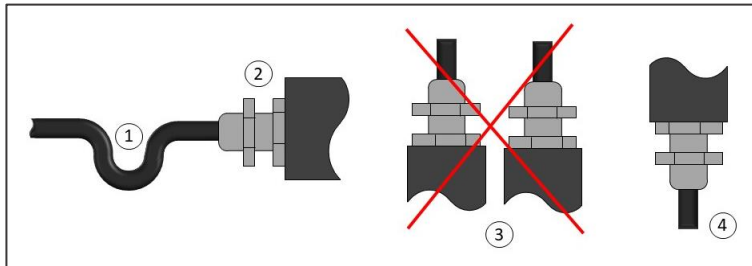

Keep the housing safe from dust and water

- i. Create a loop with the cable just before it reaches the housing.
- ii. Securely tighten the screw connection at the cable entry.
- iii. Always mount the housing with the cable entries facing downward.
- iv. Seal any unused cable entries with a plug.

4.8 EARTH CONNECTION



MEF 2100 Flow meters detect small Electrical signals from electrodes when conductive fluid flows through their magnetic field, but electrical noise can interfere. To minimize noise, ensure the pipe, fluid, flow meter body, and transmitter are all connected to the same earth ground with the earth cable as short as possible.

①

Provide a quality Earth ground connection to the meter. From best to worst, grounding options include (stranded wire 14-18 AWG):

②

Earth grounding rod driven into the ground

③

Earth wire connected directly to the building electrical service panel ground.



4.9 CHARACTERISTIC AND CONNECTION OF CABLE

4.9.1 EXCITING CURRENT CABLE

Two conductor and insulating rubber- covered cables can be used as exciting current cables. Suggested model is RVVP2*0.3mm². Length of exciting current cable should be equal to that of signal cable. When the model STT3200 cables are used for exciting current and signals, two cables can be put together as one cable.

4.9.2 FLUX SIGNAL LINE

When we use Remote Type Model i.e separate transmitter and sensors to measure the flow of a fluid that conducts electricity well (over 20 μ S/cm), we can use a special communication cable called PVVP 2*0.2 mm². This cable is 10 meters long, has a metal shield, and is covered with plastic. The one end of the signal cables are internally connected with flow tube. The Transmitter sends out signals that help reduce interference, making the flow measurement more accurate.

4.9.3 OUTPUT AND POWER LINE

All cables for signal transferring and power supply have to be prepared by users. However, it should be careful to choose the cables that meet the upper limit load of consuming current.

Note: When the DIP switch next to the terminal is set to ON state, the converter from its inside can provide +28V power supply and up-pull 10k Ω resistance to output Frequencies (PUL) to isolated OC

gate, Alarm Output (ALMH.ALML), and Status Control (INSW).Therefore, when Transmitter has frequency output and works with sensor together, DIP switch can be set as ON getting frequency signals from POUT and PCOM terminals. .

Pulse current output, alarm current output and external power supply can be seen in pic 4.9.1

- (1). When inductive load is connected to converter, diode should be used as in Pic.4.9.1
- (b)

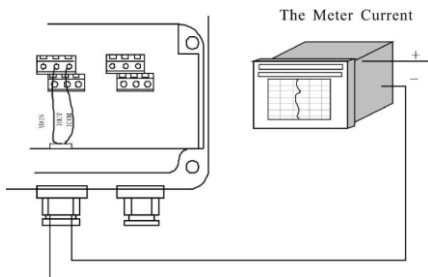

Output current circuit Pic.4.9.1

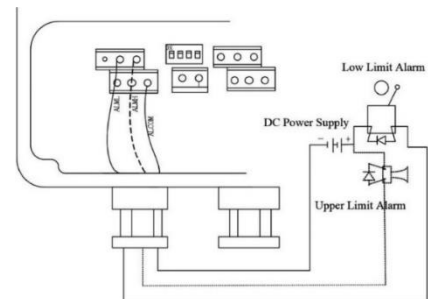

Connection of alarm output

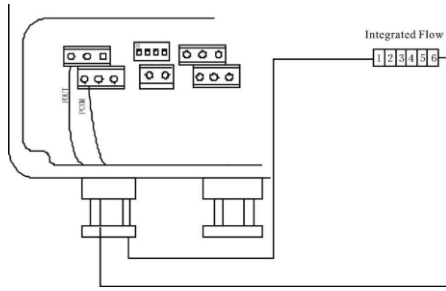

Connection of electronic counter

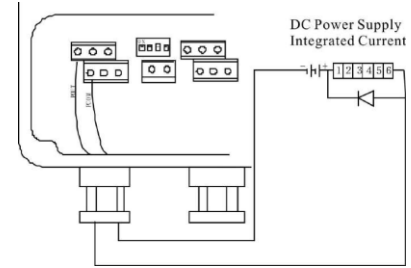

Connection of electro-magnet counter

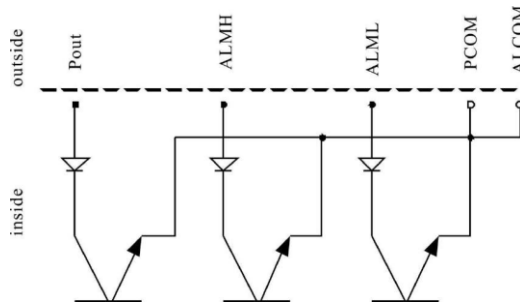

Connection of OC gate

4.9.4 GROUNDING

Contact area of copper Connector PE on Transmitter Cabinet for grounding should be larger than 1.6 mm Contact resistance should be less than 10Ω.

4.10 DIGITAL OUTPUT AND CALCULATIONS

Digital output means frequency output and pulse output, and both of them use the same output point, so user can choose only one type of them but not both.

4.10.1 FREQUENCY OUTPUT

Frequency output range is 0~5000HZ, and corresponding the percent of flux.

$$F = \frac{\text{Measure value}}{\text{Full scale value}} \cdot \text{frequency range}$$

The upper limit of frequency output can be adjusted. It can be choose from 0 ~ 5000HZ, and also can be choose low frequency: such as 0 ~ 1000HZ or 0 ~ 5000HZ.

Frequency output mode generally can be used in control application, because it responds to the percent flux. Users can choose pulse output when the equipment is applied to count.



4.10.2 PULSE OUTPUT MODE

Pulse output mainly applies in count mode. A pulse output delegates a unit flux, such as 1L or 1M3 etc. Pulse output unit divide into 0.001L, 0.01L, 0.1L, 1L, 0.001M3, 0.01M3, 0.1M3, 1 M3 .When users choose the pulse unit, they should notice the match of the flux range of flow meter and pulse unit. For volume flux, count formula as follows:

$$QL=0.0007854 \times D^2 \times V \text{ (L/S)}$$

$$\text{OR } QM=0.0007854 \times D^2 \times V \times 0.001 \text{ (M3/S)}$$

Note: D-nozzle (mm)
V-velocity of flow (m/s)

The setting of pulse unit should match flow rate in working site. If the flow rate is large but the pulse unit setting is small, the number of pulse outputs will exceed the limit. Generally, pulse output should be controlled below 3000 Pulse/Second. Conversely, if the flow rate is small but the pulse unit is set too large, it will take too long time to generate a pulse.

Meanwhile, pulse output is different from frequency output. Each pulse corresponds to a specific volume of fluid passing through the meter.

4.10.3 THE CONNECTION OF DIGITAL OUTPUT

Digital output have two connected points: digital output connected point, digital ground point, vb symbol as follows:

- POUT digital output point;
- PCOM digital ground point;
- POUT is collector plough output; user may refer to next circuit to connect

4.10.4 THE CONNECTION OF DIGITAL VOLTAGE OUTPUT

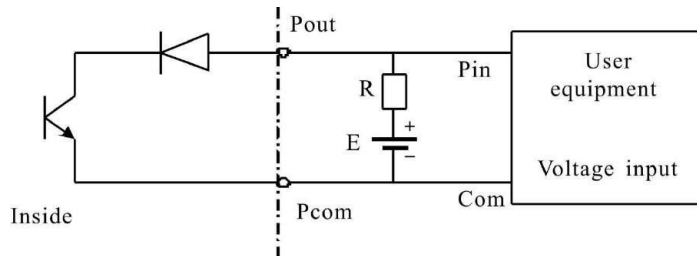

Pic.4.10.4 The connection of digital voltage output



4.10.5 DIGITAL OUTPUT CONNECT ELECTRICITY COUPLING (PLC ETC.)

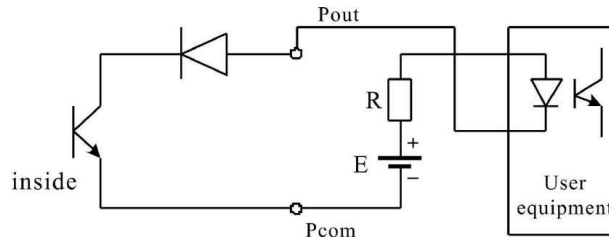

Pic. 4.10.5 Digital output connect to electricity coupling

Commonly user's electricity coupling current is about 10mA, so $E/R=10\text{mA}$, $E=5\sim 24\text{V}$.

4.10.6 DIGITAL OUTPUT CONNECT RELAY

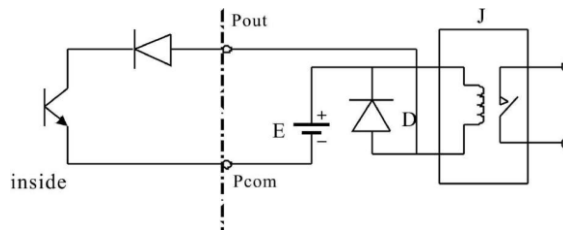

Pic. 4.10.6 Digital output connect relay

Commonly relay needs E as 12/24 VDC is extended diode; now most middle relays have this diode inside. If don't have, user should connect one diode outside.

4.11 ANALOG OUTPUT AND CALCULATIONS

4.11.1 ANALOG OUTPUT

There is 4~20mA, user can select from parameter setting.
Simulation signal output inner is 24V under 0~20mA, it can drive 750 Ω resistance.
The percent flux of simulation signal output:

$$I_0 = \frac{\text{Measure value}}{\text{Full scale value}} \bullet \text{the scale of current} + \text{the zero point of current}$$

4.11.2 ANALOG OUTPUT ADJUSTMENT

(1) THE CONVERTER ADJUST PREPARATIVE

When the Transmitter is running 15 minutes, the inner of transmitter becomes stabilization. Preparative 0.1% amperemeter or 250 Ω 、0.1% voltage instrument.

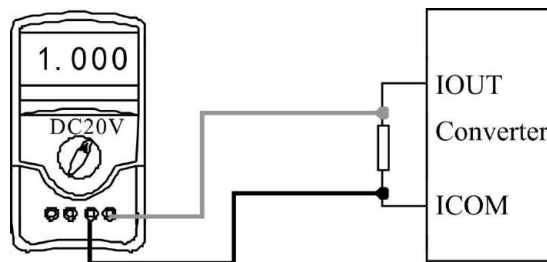



2) ZERO CURRENT CORRECTION

When the transmitter getting into parameter setting, selecting to “Analog Zero” and enter to it. When the flow rate is zero, the transmitter will display a flow rate reading of 0. At this point, adjust the parameters on transmitter program to ensure the ammeter reads 4 mA. ($\pm 0.004\text{mA}$).

(3) FULL SCALE CURRENT CORRECTION

Enter the transmitter's parameter settings and select "analog Range", then adjust the parameters on transmitter program to ensure the ammeter reads 20 mA. To ensure optimal performance, the flow meter is factory-calibrated for a 4-20 mA analog output with zero current set at 4A and full range current set at 20mA.

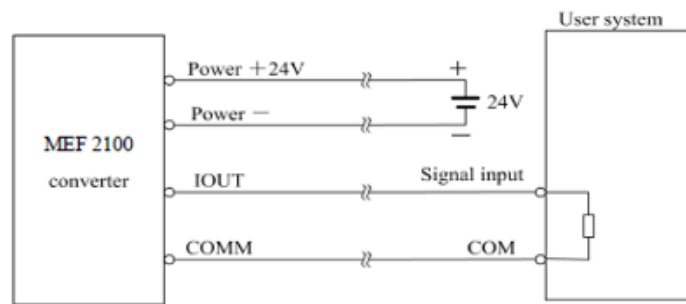

4-20 mA analog output wiring diagram

(4) CURRENT LINEARITY CHECK

You can place the standard signal source in 75%、50%、25%,and check the linearity of current output



5 START UP

5.1 SWITCHING ON THE POWER

After connecting the MEF 2100 electromagnetic flowmeter converter and sensor to the pipe, follow these steps before proceeding:

- i. Verify that all electrical connections are properly secured and insulated.
- ii. Ensure that the power supply voltage and current rating match the flow meter specifications.
- iii. Switch on the main power supply to the flow meter system.
- iv. Confirm that the flow meter displays a zero flow rate when there is no flow in the pipeline.
- v. Confirm that the flow readings are accurate and stable.
- vi. Ensure that all safety protocols are followed during the power-up process.
- vii. Be prepared to shut down the system immediately if any abnormal conditions are observed.

5.2 OPERATION

KEY AND DISPLAY

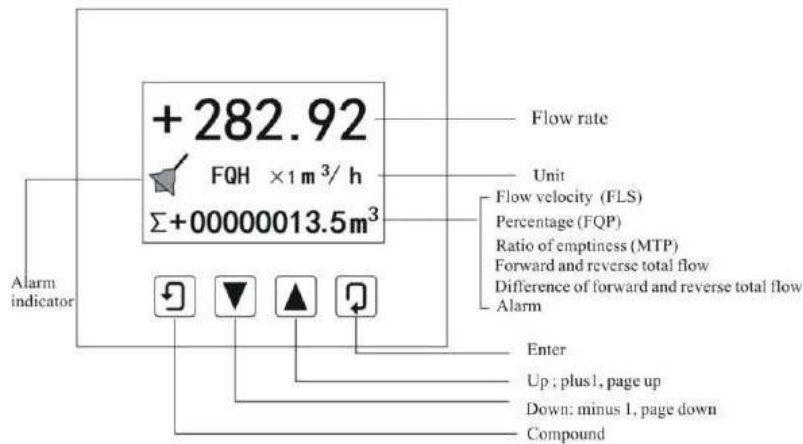

5.3 PARAMETERS AND SETTING

After power on, the instrument comes into measure mode automatically, and under this mode it can work normally and display data. Under the parameter setting mode, user can set the parameter by the four keys.



5.4 REMOTE TYPE LCD DISPLAY



Note: During measurement, press the "compound key" and "Enter" buttons simultaneously to access the programming page. You will then be prompted to enter the password.. If you want to return to measurement display, push "Enter" for several seconds.

5.5 SETTING PARAMETERS

After Electromagnetic flow meter installed to the pipe, user could do the next work firstly:

5.6 KEYS' FUNCTION IN SELF-DIAGNOSIS WAY

"Down" key: Select display data on lower line on screen;
"Up" key: Select display data on higher line on;
"Compound" key + "Enter" key: Entering into parameter setting menu
"Enter" key: Press this key to enter into different program parameters.

Under measure mode, user could adjust the LCD contract by press "Compound" key + "Up" key or "Compound" key + "Down" key for several seconds;

5.7 FUNCTION KEYS FOR PARAMETERS SETTING

"Down" key: Subtract 1 from the number at cursor area;
"Up" key: Plus 1 to the number at cursor area;
"Compound" key + "Down" key: Cursor turns left;
"Compound" key + "Up" key: Cursor turns right;
"Enter" key: In/Out submenu;
"Enter" key: Press two seconds under any state and will return to measure Mode.

Note:

- "Compound" key should work with "UP" key or "Down" key at the same time, like Compound Key + UP key or Compound Key + Down Key;
- The meter will automatically return to measurement mode after 3 minutes when in the parameter setting pages



- In Flow Zero , you can move the cursor to + or - on left side, and use
- “Down” or “Up” to switch + and -;

5.8 FUNCTION KEYS FOR SETTING PARAMETERS

FUNCTIONS SELECT MENU

Press “Compound”+ “Enter” keys, to enter into function select menu page, and press “Up” or “Down” key to select, there are three functions as below:

Code	Functions	Notes
1	Parameters Set	Select this function for entering into program parameters.
2	Clr Total Rec	Select this function for resetting the total flow consumption.
3	Fact Modify Rec	Select this function for checking the factor’s modified records

PARAMETERS SET

Press “Compound “+”Enter” keys, it displays “Parameters Set” input password and after entering the password,
Press “Compound “+”Enter” key, enter parameters setting status.

CLR TOTAL REC

Press “Compound “+”Enter” keys, enter parameters selection, then press “Up” key, find “Clr Total Rec”, input password “10000” (default is 10000, user can also pre-set the Clr Total Rec password), when the password becomes “00000”, the totalizer become “0” in flow meter.

FACT MODIFY REC

Press “Compound “+”Enter” keys, enter parameters selection, then press “Up” key, find “Fact Modify Rec” (Detailed consult the Appendix Five).

5.9 SETTING PARAMETERS IN MENU

There are 54 parameters, that can be modified by the user. The List of Parameters is shown below:

SETTING PARAMETERS IN MENU

CODE	PARAMETERS	SET	PASSWORD GRADE	DETAILS
1	Language	Select	2	English
2	Comm. Address	Set count	2	0~99
3	Baud Rate	Select	2	300~38400



4	Sensor Size	Select	2	3~3000
5	Flow Unit	Select	2	L/h, L/m, L/s/, m ³ /h, m ³ /m, m ³ /s, UKG, USG
6	Flow Range	Set count	2	0~99999
7	Flow Rspns	Select	2	1~50
8	Flow Direct	Select	2	Plus/ Reverse
9	Flow Zero	Set count	2	0~±9999
10	Flow Cutoff	Set count	2	0~599.99%
11	Cutoff Ena	Select	2	Enable/Disable
12	Total Unit	Select	2	0.001m ³ ~1m ³
13	Sigma Ena	Select	2	Enable/Disable
14	Analog Type	Select	2	0~10mA/4~20A
15	Pulse Type	Select	2	Frequency/Pulse
16	Pulse Fact	Select	2	0.001m ³ - 1m ³ 0.001 L - 1 L 0.001 USG - 1 USG
17	Frequency Max	Select	2	1~5999 HZ
18	Mtsnsr Ena	Select	2	Enable/Disable
19	Mtsnsr Trip	Set count	2	59999 %
20	Alm Hi Ena	Select	2	Enable/Disable
21	Alm Hi Val	Set count	2	000.0~599.99 %
22	Alm Lo Ena	Select	2	Enable/Disable
23	Alm Lo Val	Set count	2	000.0~599.99 %
24	Sys Alm Ena	Select	2	Enable/Disable
25	Clr Sum Key	Set count	3	0-99999
26	Snsr Code1	User set	4	Finished Y/ M
27	Snsr Code2	User set	4	Product number
28	Field Type	Select	4	Type1,2,3
29	Sensor Fact	Set count	4	0.0000~5.9999
30	Line CRC Ena	Select	2	Enable/Disable
31	Lineary CRC1	User set	4	Set Velocity
32	Lineary Fact 1	User set	4	0.0000~1.9999
33	Lineary CRC2	User set	4	Set Velocity
34	Lineary Fact 2	User set	4	0.0000~1.9999
35	Lineary CRC3	User set	4	Set Velocity
36	Lineary Fact 3	User set	4	0.0000~1.9999
37	Lineary CRC4	User set	4	Set Velocity
38	Lineary Fact4	User set	4	0.0000~1.9999



39	Fwd Total Lo	Correctable	5	00000~9999
40	Fwd Total Hi	Correctable	5	00000~9999
41	Rev Total Lo	Correctable	5	00000~9999
42	Rev Total Hi	Correctable	5	00000~9999
43	PlsntLmtEna	Select	3	Enable/Disable
44	PlsntLmtVal	Select	3	0.010~0.800m/s
45	Plsnt Delay	Select	3	400~2500ms
46	Pass Word 1	User correct	5	00000~99999
47	Pass Word 2	User correct	5	00000~99999
48	Pass Word 3	User correct	5	00000~99999
49	Pass Word 4	User correct	5	00000~99999
50	Analog Zero	Set count	5	0.0000~1.9999
51	Anlg Range	Set count	5	0.0000~3.9999
52	Meter Fact	Set count	5	0.0000~5.9999
53	Meter Code 1	Factory set	6	Finished Y /M
54	Meter Code 2	Factory set	6	Product Serial No
55	Check Mode	Factory set	2	No Parity, Odd Parity, Even Parity

There are 54 parameters, user can set every parameter. The List of Parameters is shown below: Parameters of transmitters can decide the running status, process and output ways as well as state of output. Correct option and setting of parameters can keep the transmitters running optimally and get higher accuracies of output both in display and in measurement.

Grade 1 to grade 5 of passwords are for users and grade 6 of password is for manufacturer. Users can reset their passwords of grades 1~4 in grade 5.

Users can check transmitters parameters by using any grade of password. However, if users want to change parameters of transmitters, different grade of passwords have to be used by the user

Grade 1 of Password	Users can only read parameter.
Grade 2 of password (set by manufacturer as 03210):	Users can change 1~24 parameters.
Grade 3 of password (set by manufacturer as 06108):	Users can change 1~25 parameters.
Grade 4 of password (set by manufacturer as 07206):	Users can change 1~38 parameters.
Grade 5 of password (Fixed):	Users can change 1~52 parameters.



Password Grade 5 can be set by skilled users. Grade 4 is mainly used for resetting total volume in password. Grades 1~3 can be set by anyone who can be chosen by users

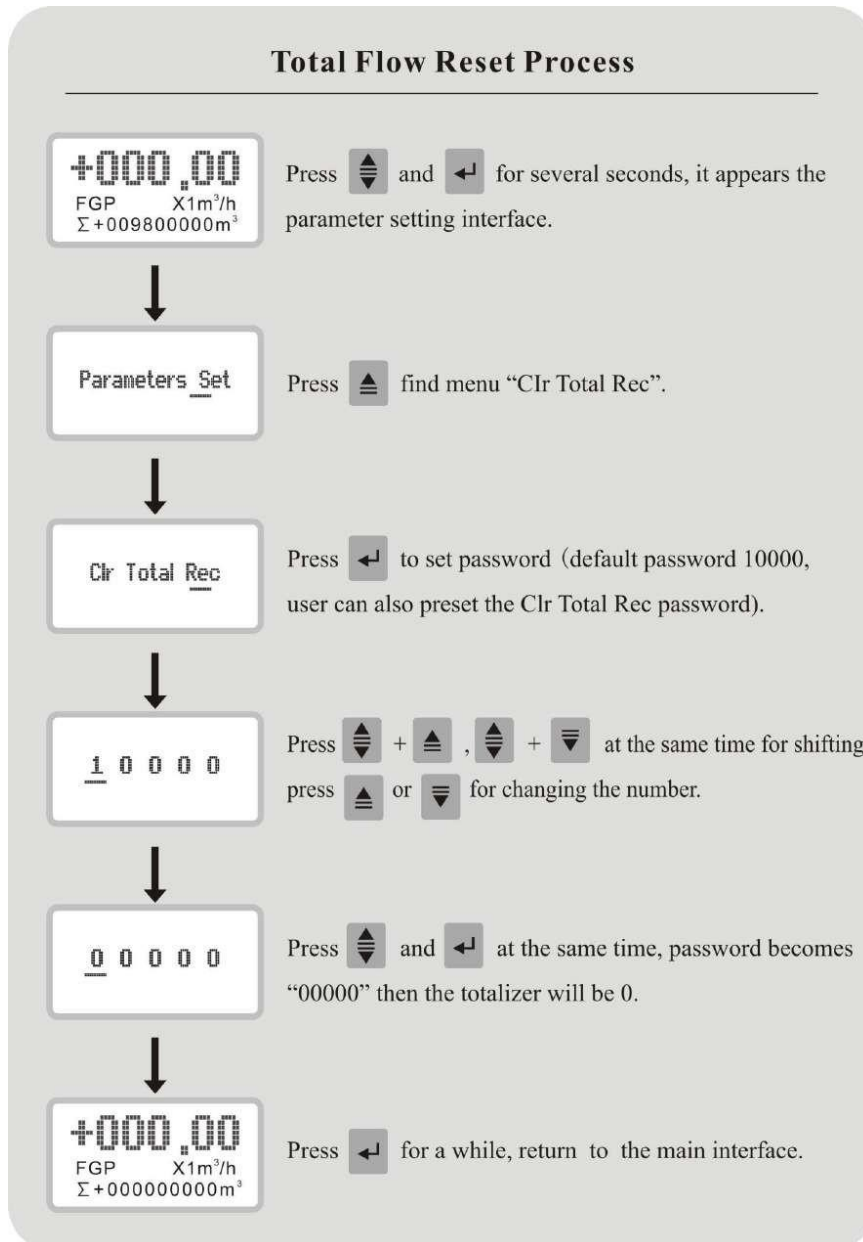

5.10 PROGRAM PARAMETERS

LANGUAGE

There are multi languages for Transmitter operation. They can be set by users according to the user's needs.

COMM. ADDRESS

It means this instrument's address when communicates with many, and has



01~99, holding the 0.

BAUD RATE

300, 1200, 2400, 4800, 9600, 38400, baud rate.

SENSOR SIZE

Transmitters can be equipped with some different sensors that have different diameter of measuring pipes. The pipes in different diameters from 3mm to 3000mm can be chosen by the manufacturer.

FLOW UNIT

The flow unit can choose from the parameters (L/s, L/m, L/h, m3/s, m3/m, m3/h, UKG, USG), and the user can choose the proper unit according to the site requirement.

FLOW RANGE

Flow range means upper limit value, and lower limit value is set "0" automatically. So, it makes the range, and makes the relation of percent display, frequency output and current output with flow:

Percent display = (flow measure / measure range) x 100 %; Frequency output = (flow measure / measure range) x frequency full;

Current output = (flow measure / measure range) x current full + base point; Pulse output will not affect.

FLOW RESPONSE

It means time of filter measure value. The higher one can enhance the stability of flow rate and digital outputs, and fits for gross add up of pulse flow; the smaller one means fast response rate, and fits for production control.

FLOW DIRECTION

If user find that the displayed flow direction is different with actual flow direction, just need to change the direction parameter in menu. Don't need to change the installation direction of flow meter, exciting cables or signal cables.

FLOW ZERO

Flow zero correction ensures that the flow meter accurately reads zero flow when there is no fluid movement,. Flow zero is shown as velocity of flow, mm/s

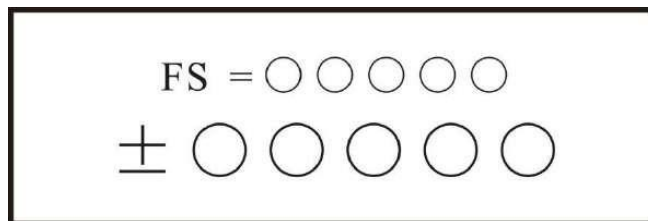

Transmitter's zero-flow correction displays like this:

Upper small words: FS means measure value of zero;

Lower large words: correction value of zero.

When FS is not "0", make FS = 0. Note: if change the value on next line and FS increases, please change the "+, -" to correct FS to zero.

Flow zero is the compound value of the sensor, and should be recorded in sensor list and band. The unit will be mm/s, and the sign will be opposite with correction value.



FLOW CUT-OFF

This function sets the flow cut-off for flow measurement. The meter will report all flow measurements below the threshold as zero flow. This cut-off function is necessary to prevent small random noise signals from being reported as flow. It is based on a percentage of the full scale flow rate..

TOTAL UNIT

Transmitter display is counter with 9 bits, and the max is 999999999. Integrator units are L, m3 (liter, meter cube).
Flow integrator value:

0.001L	0.010L	0.100L	1.000L
0.001m ³	0.010m ³	0.100m ³	1.000m ³

SEGMAN ENA

When “Segman Ena” is “enable”, if the flow flows, the sensor will export pulse and current. When it is “disable”, the sensor will export pulse as “0” and current as “0” (4mA or 0mA) for the reverse flow application.

OUTPUT CURRENTS

Output current types can be chosen by users as 4~20mA.

PULSE TYPE

The flow meter provides both pulse and frequency outputs, delivering digital signals proportional to the flow rate. The pulse output generates a serial square wave form, with each pulse representing a discrete volume of fluid passing through the meter. The frequency output also produces a continuous square wave form, where the frequency of the pulses corresponds to the flow rate, offering real-time and accurate flow measurement. These outputs facilitate seamless integration with control systems, ensuring precise flow data for a variety of applications.

Frequency output and pulse output are usually from OC gates so that DC power supplies and load resistors have to be required.

PULSE FACT

Equivalent pulse Unit is referred to one pulse for value of flow. The range of pulse equivalent can be chosen

Pulse Equivalent	Flow	Pulse Equivalent	Flow
1	0.001L/cp	5	0.001m ³ /cp



2	0.01L/cp	6	0.01m ³ /cp
3	0.1L/cp	7	0.1m ³ /cp
4	1.0L/cp	8	1.0m ³ /cp

Under the same flow conditions, smaller pulse intervals result in higher frequency output and reduced measurement error. The highest pulse output is 100 counts per second (cps), and the electromagnetic counter can register 25 frequency per second.

FREQUENCY MAX

The meter's programmable frequency maximum value of 1-5000 Hz corresponds to the analog range, providing flexibility and precision in adapting to various measurement requirements. The meter's programmable frequency maximum value of 1-5000 Hz corresponds to the analog range, providing flexibility and precision in adapting to various measurement requirements

MTSNSR ENA

The state of empty pipe can be detected with the function of converter. In the case of Empty Pipe Alarm, if the pipe was empty, the signals of analog output and digital output would be zero and displayed flow would be zero, too. The transmitter can detect the state of an empty pipe. During an Empty Pipe Alarm condition, both analog and digital outputs will register zero, and the displayed flow rate will indicate zero when the pipe is confirmed to be empty.

MTSNSR TRIP

When the pipe is full of liquid (whether flowing or not), the parameter of "Mtsnsr" could be modified more easily. The parameter displayed upper line is real MTP, and the parameter displayed below is the "Mtsnsr trip" that should be set. When setting "Mtsnsr trip", you could be according to the real MTP, the value that should be set is usually three to five times of real MTP.

ALM HI ENA

Users can choose "Enable" or "Disable".

ALM HI VAL

The upper limit alarm parameter is expressed as a percentage of the flow range and can be configured by setting a value between 0% and 199.9%. When the flow percentage exceeds the configured value, the transmitter outputs an alarm signal.

ALM LO VAL

The same as upper limit alarm.
Select "Enable", with excitation alarm function.
Select "Disable", cancel this excitation alarm function

CLR SUM KEY

The user can set the password with a password above the third level, and then set the password in the total reset menu.



SENSOR CODE

The sensor code can be used to mark the production time and number of the sensor to match the setting of the sensor coefficient.

SENSOR COEFFICIENT

Sensor coefficient: the calibration coefficient of the Electromagnetic flow meter. The coefficient is obtained from the actual standard and is stamped on the sensor plate.

FIELD TYPE

There are three exciting frequency types: 1/16 frequency (type 1), 1/20 frequency (type 2), 1/25 frequency (type 3). The small caliber should select 1/16 frequency, and large caliber should select 1/20 frequency or 1/25 frequency. In use, first select the excitation type 1. If the zero point of the flow rate of the meter is too high, then select type 2 or type 3.

FWD TOTAL LO, HI

The total high and low settings allow adjustment of both positive and reverse cumulative total values, primarily for instrument maintenance and replacement purposes. Access requires a 5-level password, enabling users to modify the positive cumulative amount as needed. The maximum digit capacity of the cumulative value set as 999999999.

REV TOTAL LO, HI

The total high and low settings allow adjustment of both positive and reverse cumulative total values, primarily for instrument maintenance and replacement purposes. Access requires a 5-level password, enabling users to modify the reverse cumulative amount as needed. The maximum digit capacity of the cumulative value set as 999999999.

PLSNTLMTEN

For applications involving paper pulp, slurry, and similar materials, flow measurement may be affected by "spike items" such as solid grains or stones that can cause friction or impact the measurement electrodes. The transmitter mitigates these disturbances using variance suppression algorithms, which involve adjusting three parameters to select the appropriate disturbance handling characteristic. Enabling this feature activates variance suppression, while disabling it deactivates this functionality.

PLSNTLMTVL

This coefficient can disturb the variation of spike items disturb, and calculate as percent of flow velocity, thus ten grades: 0.010m/s, 0.020m/s, 0.030m/s, 0.050m/s, 0.080m/s, 0.100m/s, 0.200m/s, 0.300m/s, 0.500m/s, 0.800m/s, and the smaller percent, the higher sensitivity of pointed items restrain.

Note: In the application, the higher the sensitivity is not necessarily the better, but the choice should be tested according to the actual situation.

PLSNT DELAY

This coefficient determines the duration, in milliseconds, for suppressing disturbances caused by spike items. If the duration is shorter than the time it takes for flow changes to occur, the transmitter will interpret it as a disturbance from spike items. If the duration is longer, the transmitter will consider it a natural flow change. The appropriate parameter should be selected based on actual conditions.

USER'S PASSWORD 1~4

Users can use 5 grades of passwords to correct these passwords.



ANALOG ZERO

When the transmitter is manufactured, the output current is calibrated to the zero scale, ensuring an accurate output of either 0mA or 4mA..

ANALOG RANGE

When the transmitter is manufactured, the output current is calibrated to the full scale, ensuring an accurate output of 20mA

METER FACTOR

This factor, unique to the sensor's manufacturing process, is used by the factory to standardize electromagnetic flow meter transmitters.

METER CODE 1 AND 2

Transmitter code records the date of manufacturing and serial number of transmitter.

CHECK MODE

For RS485 communication use, default is No Parity Stop 1. Options are below: No Parity Stop 1, Odd Parity Stop 1, Even Parity Stop 1
No Parity Stop 2, Odd Parity Stop 2, Even Parity Stop 2

5.11 ALARM INFORMATION

PCB of Electromagnetic flow meters transmitter uses SMT, so for user, it is unable to service, and cannot open the shell of transmitter . Intelligent transmitter have self-diagnose function. Without trouble of power and hardware circuit, any normal faults will be correctly indicated by the alarm system. This information displays  on the left of LCD :

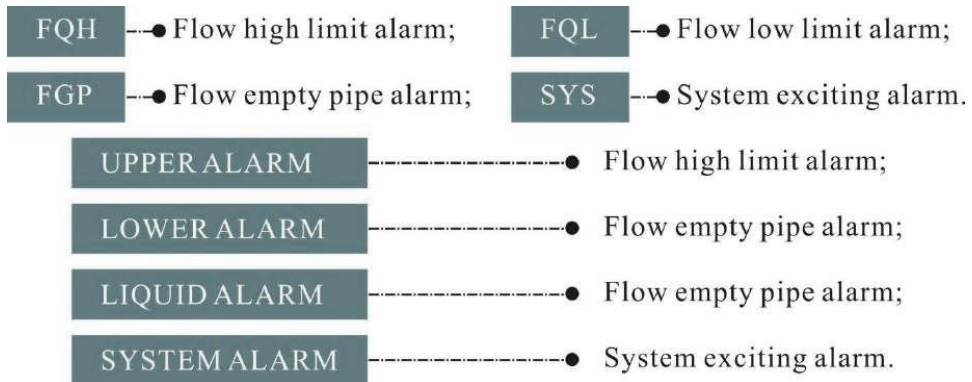



APPENDIX 1 : ON/OFF SWITCH DIAGRAM

(Only for square remote type converter)

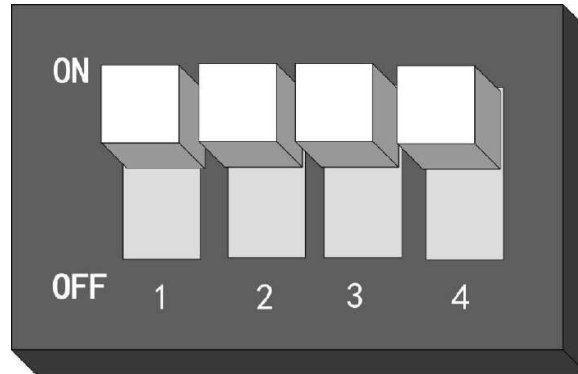

Key 1

ON: Supply up power (24V) for ALML output.

OFF: No Connection.

Key 2

ON: Pulse output to OC gate when flow verification was taken.

Connect pull-up resistor.
OFF: No Connection.

Key 3

ON: Supply up power (24V) for ALMH output.

OFF: No Connection.

Key 4

ON: Connected to RS485 terminal resistor for communication

OFF: No Connection.

Note: Terminal used for far communication only.



APPENDIX 2: FLOW COEFFICIENT MODIFICATION RECORD

Transmitter has a function of protecting the Characteristic Flow Factor. The key content is that the factor could not be modified easily. Transmitter increases a new function to record the modified procedure and modified times of flow zero, sensor factor, and meter factor, any change of these three factors could be recorded. The sensor factor and modifying times could be recorded in Test Report, and when next time testing the factor in Test Report and factor in the transmitter are compared to check whether the Characteristic Flow Factor has been changed. The detail about the Characteristic Flow Factor protection function can be found in the appendix.

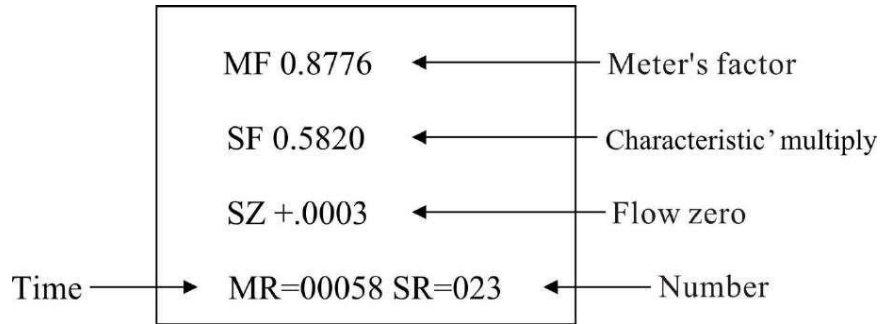

Attention !

The last record is displayed when this item is first entered, if you want to browse the history records press "down key", and could search for the last record to the thirty-two record ahead. Finally the times of record modified (MR) should be written down on the paper before next time test.



APPENDIX 3 : LIGHTNING PROTECTION NOTES

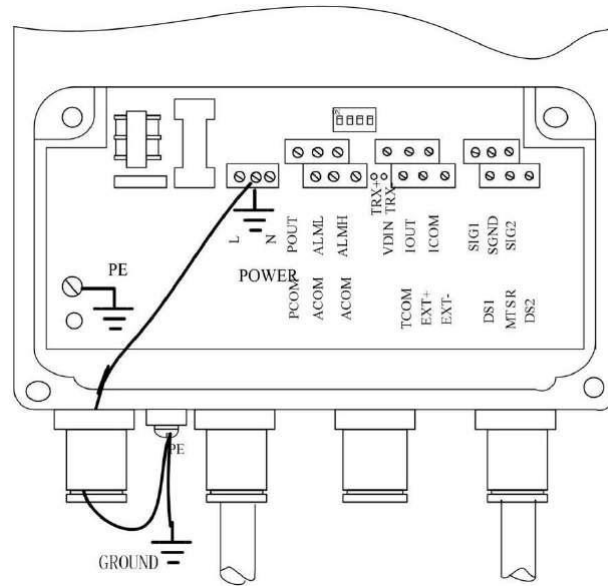

During installation, users must securely connect the transmitter's grounding terminal to the shell and ensure both are reliably earthed. This allows electrical current to be safely discharged to the earth through the lightning protection gas discharger. Failure to reliably earth the shell may result in personal injury during lightning events if someone is operating the transmitter. For specific details, refer to the connection diagram.



APPENDIX 4: FLOW RANGE AND VELOCITY TABLE

SIZE(mm)	FLOW RANGE & VELOCITY TABLE						
	0.1 M/S	0.5 M/S	1 M/S	3 M/S	5 M/S	10 M/S	12 M/S
DN10	0.02	0.14	0.28	0.84	1.41	2.82	4.24
DN15	0.06	0.31	0.63	1.9	3.18	6.36	9.54
DN20	0.11	0.56	1.13	3.39	5.65	11.31	16.96
DN25	0.17	0.88	1.76	5.3	8.83	17.67	26.5
DN32	0.28	1.44	2.89	8.68	14.47	28.95	43.42
DN40	0.45	2.26	4.52	13.57	22.62	45.23	67.85
DN50	0.7	3.53	7.06	21.2	35.34	70.68	106.02
DN65	1.19	5.97	11.94	35.83	59.73	119.46	179.19
DN80	1.8	9.04	18.09	54.28	90.47	180.95	271.44
DN100	2.82	14.13	28.27	84.82	141.37	282.74	424.11
DN125	4.41	22.08	44.17	132.53	220.89	441.78	662.68
DN150	6.36	31.8	63.61	190.85	318.08	636.17	954.27
DN200	11.31	56.54	113.09	339.29	565.48	1131	1696.47
DN250	17.67	88.35	176.71	530.14	833.57	1767.2	2650.72
DN300	25.44	127.23	254.46	763.4	1272.4	2544.7	3817.03
DN350	34.63	173.18	346.36	1039.1	1731.8	3463.6	5195.41
DN400	45.23	226.19	452.38	1357.2	2262	4523.9	6785.83
DN450	57.25	286.27	572.55	1717.7	2862.8	5725.6	8588.32
DN500	70.68	353.42	706.85	2120.6	3534.3	7068.6	10602.9
DN600	101.8	508.93	1017.9	3053.6	5089.4	10179	15268.2
DN700	138.5	692.72	1385.4	4156.3	6927.2	13854	20781.6
DN800	181	904.77	1809.6	5428.7	9047.8	18096	27143.4
DN900	229	1145.1	2290.2	6870.7	11451	22902	34353.3
DN1000	282.7	1413.7	2827.4	8482.3	14137	28274	42411.5



MIAL[®]
INSTRUMENTS PVT.LTD.
Measuring & Beyond

USA OFFICE ADDRESS

MIAL INSTRUMENTS PVT. LTD.
Downtown Republic Center
325 N. St.Paul Street, Suite 3100
Dallas 75201, Texas, USA

FACTORY ADDRESS

MIAL INSTRUMENTS PVT. LTD.
856/ 6 GIDC
Makarpura, Vadodara 390010, Gujarat, India
+91-9913449547/9913449548

Email : info@mialinstruments.com
www.mialinstruments.com



**MIAL
INSTRUMENTS**
Measuring & Beyond

856/6, GIDC MAKARPURA, VADODARA - 390010
Phone : +91-9913449547 / +91-9913449548
E-MAIL : info@mialinstruments.com
WWW : www.mialinstruments.com