

| INSTALLATION & OPERATION MANUAL

MTF 500 / 600

Inline / Insertion Thermal Mass Flow Meter



MIAL[®]
INSTRUMENTS PVT. LTD.
Measuring & Beyond

www.mialinstruments.com

MTF 500/600

Inline/Insertion Thermal Gas Mass Flow Meter

Preface

- Thank you for purchasing our product.
- This manual is about the various functions of the product, wiring methods, setting methods, operating methods, troubleshooting methods, etc.
- Please read this manual carefully before operation, use this product correctly to avoid unnecessary losses due to incorrect operation.
- After you finish reading, please keep it in a place where it can be easily accessed at any time for reference during operation.



NOTE!

Modification of this manual's contents will not be notified as a result of some factors, such as function upgrading. We try our best to guarantee that the manual content is accurate, if you find something wrong or incorrect, please contact us. The content of this manual is strictly prohibited from reprinting or copying.

About this manual

- Please submit this manual to the operator for reading.
- Please read the operation manual carefully before applying the instrument. On the precondition of full understanding.
- This manual only describes the functions of the product. The MIAL Instruments pvt.ltd. Does not guarantee that the product will be suitable for a particular use by the user.

Warnings and symbols used



HAZARD!

If not taken with appropriate precautions, will result in serious personal injury, product damage or major property damage.



WARNING!

Pay special attention to the important information linked to product or particular part in the operation Manual



CAUTION!

Disregarding these instructions can result in damage to the device or to parts of the operator's plant.



INFORMATION!

These instructions contain important information for the handling of the device.



Table of Contents

Preface	1
About this manual	1
1. INTRODUCTION	3
1.1 PURPOSE OF THE MANUAL	3
1.2 OPERATING PRINCIPLE	4
1.3 TECHNICAL SPECIFICATIONS*	5
2. DESCRIPTION	6
2.1 SCOPE OF DELIVERY.....	6
2.2 NAME PLATES	6
2.3 DIMENSIONS OF THERMAL MASS FLOW METER.....	7
3. INSTALLATION	9
3.1 SITE SELECTION	9
3.1.1 BASIC RECOMMENDATIONS	9
3.1.2 THERMAL INSULATION	9
3.1.3 STRAIGHT LENGTH REQUIREMENT	10
3.2 PIPE WORK REQUIREMENT	12
3.3 INSTALLATION STEPS.....	12
4 ELECTRICAL CONNECTIONS	13
4.1 SAFETY INSTRUCTIONS.....	13
4.2 INSTRUCTION OF SENSOR WIRING.....	13
4.3 INSTRUCTION OF TRANSMITTER WIRINGS.....	14
4.4 THE WIRINGS OF POWER SUPPLY.....	14
4.5THE WIRINGS OUTPUT	14
5 OPERATIONS	16
5.1 DISPLAY.....	16
5.2 PARAMETERS SETUP	17
Appendix 1 The Density and Conve Coeffi of Common Gas	24
Appendix 2 Upper Range Value of Common Gas	27

1. INTRODUCTION

1.1 PURPOSE OF THE MANUAL

Overview:

Welcome to the user manual for the Mial MTF 500/600 Inline/Insertion Thermal Gas Mass Flow Meter. This comprehensive guide is designed to assist operators, maintenance personnel, and system integrators in understanding, installing, operating, and maintaining the Mial MTF 500/600 Inline/Insertion Thermal Gas Mass Flow Meter.

Objectives:

Clarification of Functionality: This manual aims to provide a clear understanding of the principles and functionality of the Mial MTF 500/600 Inline/Insertion Thermal Gas Mass Flow Meter. Users will gain insights into its design, components, and how it precisely measures fluid flow.

Guidance for Installation:

Step-by-step instructions and considerations for proper installation are provided to ensure optimal performance. Safety precautions are emphasized to create a secure working environment.

Training and Familiarization:

Users will be guided through the features, controls, and indicators of the flow meter, facilitating efficient operation. This section aims to serve as a valuable training resource for users at various experience levels.

Maintenance and Troubleshooting Assistance:

Learn about routine maintenance procedures and effective troubleshooting techniques. This manual empowers users to address common issues and perform regular maintenance to enhance the longevity of the Mial MTF 500/600 inline/Insertion Thermal Gas Mass Flow Meter.

Intended Audience:

This manual is intended for operators, maintenance personnel, and system integrators involved in the installation, operation, and maintenance of the Mial MTF 500/600 Inline/Insertion Thermal Gas Mass Flow Meter. It is suitable for both novice users seeking basic guidance and experienced professionals looking for specific details.

Important Notes:

Please read through the manual carefully, adhering to safety guidelines and following instructions precisely. If any uncertainties arise during the installation, operation, or maintenance processes, seek assistance from qualified personnel or our customer service / support team.

Reference to Other Documentation:

Refer to the accompanying technical specifications document for in-depth details about the Mial MTF 500/600 Inline/Insertion Thermal Gas Mass Flow Meter. Additional resources can be found on our website.

Intended use



CAUTION!

Responsibility for the use of the measuring devices with regard to suitability, intended use and corrosion resistance of the used materials against the measured fluid lies solely with the operator.



INFORMATION!

The manufacturer is not liable for any damage resulting from improper use or use for other than the intended purpose

Certification



The manufacturer certifies successful testing of the product by applying the ISO marking

1.2 OPERATING PRINCIPLE

Thermal mass flow meters employ the thermal dispersion principle whereby the rate of heat absorbed by a fluid flowing in a pipe or duct is directly proportional to its mass flow. In a typical thermal flow meter gas flowing over a source of heat absorbs the heat and cools the source.

As flow increases, more heat is absorbed by the gas. The amount of heat dissipated from the heat source is proportional to the gas mass flow and its thermal properties. Therefore, measurement of the heat transfer supplies data from which a mass flow rate may be calculated.

The format of gas velocity and power consume is shown as below:

$$v = \frac{K[Q/f1T]^{0.87}}{\rho g} \dots\dots\dots(1)$$

Where :

ρg is specific gravity of medium K is balance coefficient

L'1T is differential temperature

V is velocity

Q is heater power

The medium temperature range of meter is -40°C to 220 °C.

In the format (1), the specific gravity of medium is related to the density:

$$\rho = \rho_{101.325} \times \left(\frac{101.325 + P}{101.325} \right) \times \left(\frac{273.15 + 20}{273.15 + T} \right) \dots\dots\dots(2)$$

Where:

ρg is the medium density in working condition(kg/m³)

ρ_n is the medium density in standard condition, 101.325kPa and 20°C (kg/m³)

P is the pressure in working condition(kPa) _____

T is the temperature in working condition (°C)

It can be seen from equations (1) and (2) that the flow velocity has a certain functional relationship with the working pressure, gas density, and working condition temperature.

Since the temperature of the sensor is always automatically about 30°C higher than the temperature of the medium (environment), thermal mass flow meter does not require temperature and pressure compensation in principle.



1.3 TECHNICAL SPECIFICATIONS*

Operation and performance

Flow_measurement

Thermal dispersion

Fluid types

Various gases (Except the acetylene)

Fluid properties

Thermal Conductive Fluid

Pipe sizes

Inline : DN 15mm –DN 300mm Insertion :

DN 32mm – DN 4000mm

Pipe materials

Standard: Carbon steel

Optional : Stainless steel,Plastic, etc

Flow accuracy

Inline : $\pm 1.0\%$

Insertion : $\pm 1.5\%$

Velocity 0.1~100

Nm/s

Flow rate turndown

100:1

Measurement parameters

Mass flow rate, Nominal flow rate, Flow totalizer, Velocity,

Certification

Calibration certification

Electronics

Transmitter Type

Standard: Integral

Optional :Remote

(Wall mounted enclosure with 10m cable)

Enclosures Transmitter Type

Aluminum

Enclosure IP rating

IP65

Power supply

24 VDC,2A

Use SMPS when employing AC power

Ambient temperature

32°F to 140°F (0°C to 60°C)

Standard output

Analog output 4-

20mA Pulse output

Alarm Output

1–2 way Relay, Normally Open state 5A/30V/DC

Network

Connection

Modbus RS 485

Response Time

1s

Flow Tube

Operating Temperature range

–40 °F to 428 °F (–40 °C to 220 °C)

Nominal Pressure

Insertion: ≤ 1.6 Mpa

Inline : ≤ 4 MPa

Process connections

ANSI class 150 Flanges

Hot-tapped Insertion

DN 15mm – 25mm = M12

DN 32mm– 100mm =M16

Materials

Stainless Steel 316

IP rating

IP65



2. DESCRIPTION

2.1 SCOPE OF DELIVERY



INFORMATION!

Do a check of the packing list to make sure that you have all the elements given in the order



INFORMATION!

Inspect the packaging carefully for damages or signs of rough handling. Report damage to the carrier and to the local office of the manufacturer.

sensor and the converter correctly, so they match by the devices serial number

2.2 NAME PLATES



INFORMATION!

Look at the device nameplate to ensure that the device is delivered according to your order. Check for the correct supply voltage printed on the nameplate

EXAMPLE OF NAMEPLATE FOR THE FLOW METER

Thermal Mass Flow Meter	
Model: _____	Measuring Range: _____
Factor: _____	Nominal Diameter: _____
Accuracy : _____	Nominal Pressure : _____
Date : _____	Serial Number : _____
 MIAL® INSTRUMENTS PVT.LTD. <i>Measuring & Beyond</i>	



2.3 DIMENSION FOR THERMAL MASS FLOW METER

INLINE THERMAL MASS FLOW METER

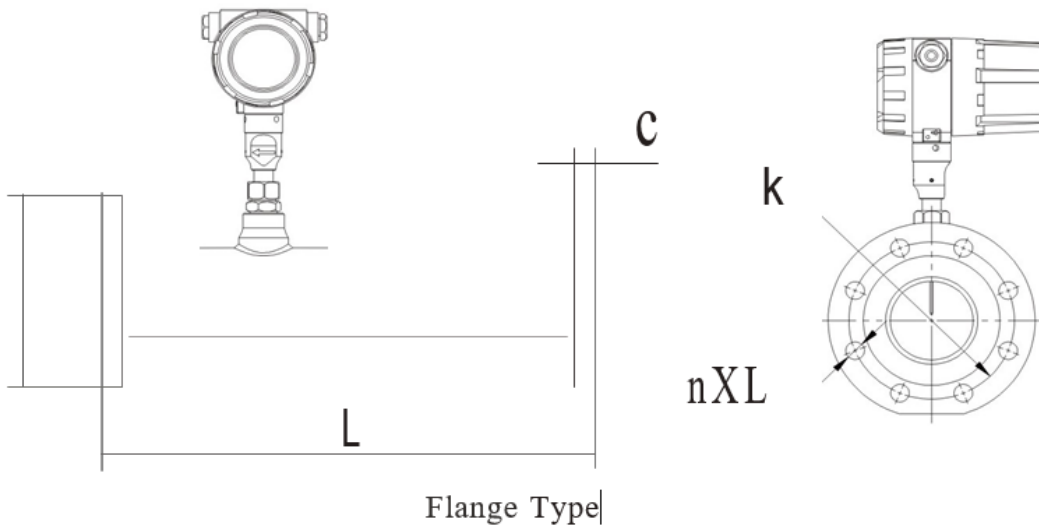

Flange Type

DIN PN16 FLANGE (UNIT: MM)

Nominal Diameter	Flange Outer diameter	Center Hole	Screw Hole	Thread	Sealing Face		Flange Thickness	Pipeline Length
DN	D	k	$n \times L$		d	f	C	L
15	95	65	4x 14	M12	46	2	14	280
20	105	75	4x 14	M12	56	2	16	280
25	115	85	4x 14	M12	65	2	16	280
32	140	100	4x 18	M16	76	2	18	350
40	150	110	4x 18	M16	84	2	18	350
50	165	125	4x 18	M16	99	2	20	350
65	185	145	4x 18	M16	118	2	20	400
80	200	160	8x 18	M16	132	2	20	400
100	220	180	8x 18	M16	156	2	22	500

For DN15-DN80, thermal mass flow meter can be produced with thread connection

Standard pressure rating is PN 16, if higher rating request, please contact us for special order.



INSERTION THERMAL MASS FLOW METER

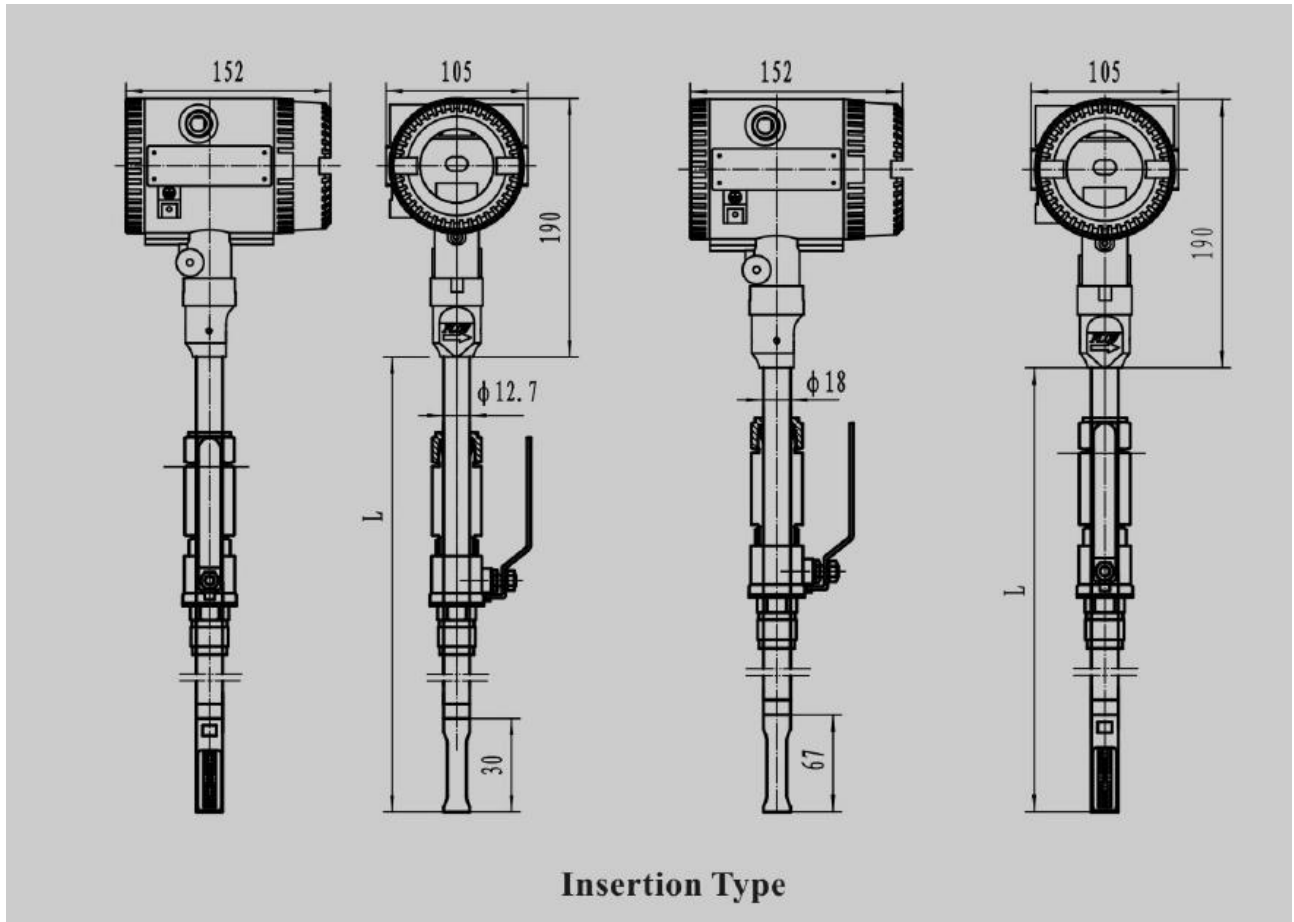



3. INSTALLATION

3.1 SITE SELECTION

When selecting a site for a flow meter, prioritize accessibility for installation and maintenance. Consider environmental factors like temperature and humidity as per guidelines. Ensure the flow profile is stable and the pipe is in good condition. Safety and ease of access for personnel should also be considered to optimize meter performance and longevity.

3.1.1 BASIC RECOMMENDATIONS

In general guidelines, it's recommended to find a location where the pipe has the longest straight segment with a clear run. This ensures smooth and consistent flow of the fluid through the meter, which is crucial for accurate measurement. A longer clear run of pipe minimizes disturbances and turbulence that could affect the meter's performance. This approach helps optimize the meter's accuracy and reliability by providing a stable flow profile for measurement.

Thermal mass flow meter require full pipe medium for correct flow measurement. For this reason , please note the following points when installing the device.

- Observe the recommended inlet and outlet requirements.
- Suitable engineering practice is necessary for the associated pipe work and installation.
- Take measure to reduce or avoid condensation.
- Ensure correct alignment and orientation of the sensor.
- The maximum permitted ambient temperatures and the medium temperature range must be observed.
- Install the transmitter in a shaded location or use a protective sun shield.
- No installation in where large vibration exists
- No exposure in the environment containing a lot of corrosive gas
- No sharing power supply with frequency converter, electric welding machine and other machines which can make power-line interference. If necessary, please add power conditioner for transmitter power supply

3.1.2 THERMAL INSULATION

- When the gas is very humid or saturated with water (e. g. Biogas), the piping and flow meter body should be insulated to prevent water droplets condensing on the measuring sensor

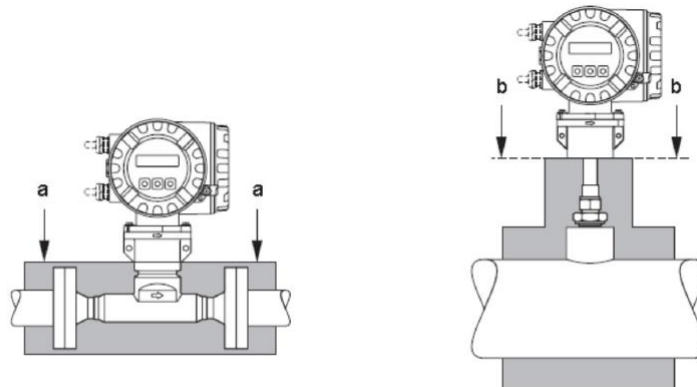

a. Maximum insulation height for the flange sensor
b. Maximum insulation height for the insertion sensor



- i** **INFORMATION!**
As a general rule thermal mass flow meter should always be installed far away from any flow disturbance.
- i** **INFORMATION!**
Where two or more flow disturbances located upstream of the meter, the recommended inlet length for the flow disturbance causing strong disturbance must be obeyed. E.g. where a valve is mounted before a bend, upstream of the flow meter, 50 x ON of pipe work is required from the valve to the flow meter
- i** **INFORMATION!**
For very light gas, such as Helium and Hydrogen, all upstream distances should be doubled.

3.1.3 STRAIGHT LENGTH REQUIREMENT

The minimum recommendations for inlet and outlet runs (without flow conditioner) are:

❖ FLANGED SENSOR

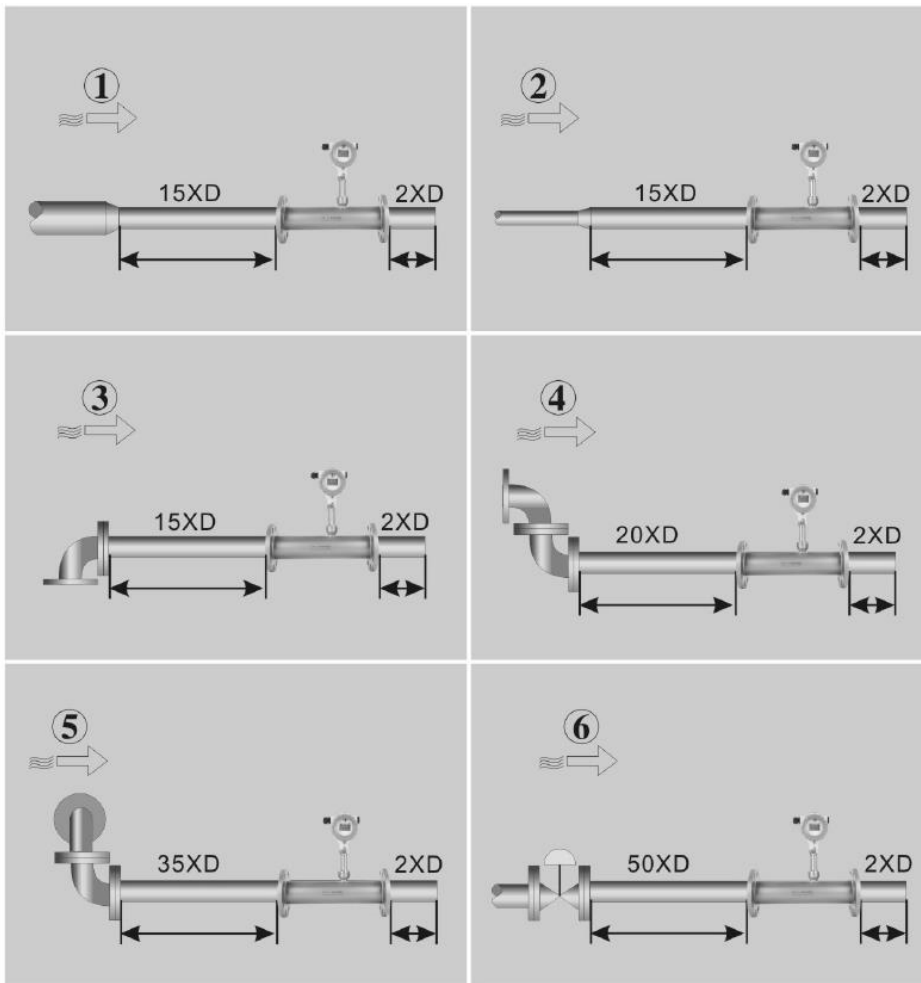



1 = Reduction

2 = Expansion

3 = 90° elbow or T-piece

4 = 2 x 90° elbow 6 = Control valve

5 = 2 x 90° elbow (three- -way valve)

❖ INSERTION SENSOR

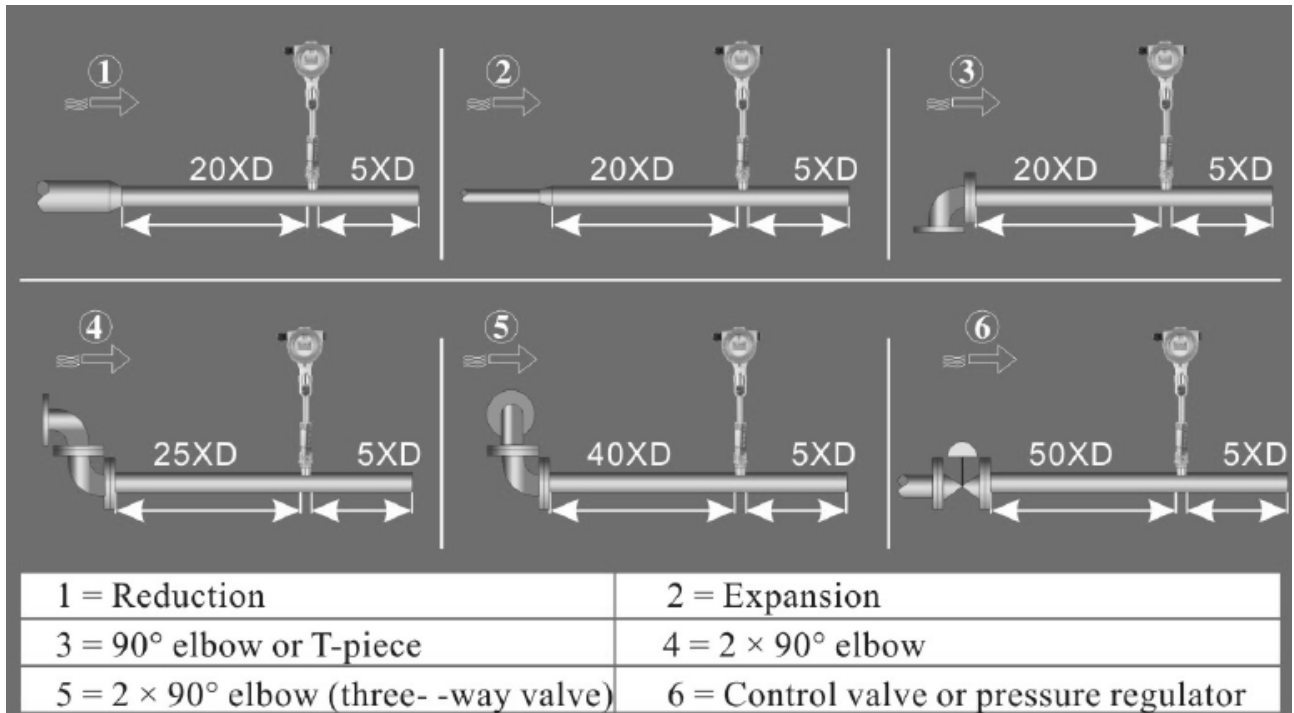

3.2 PIPEWORK REQUIREMENTS

- Good engineering practice should be followed at all times: Correct preparation, welding and finishing techniques
- Correctly sized gaskets
- Correctly aligned flanges and gaskets
- Connecting pipe work should match the internal diameter of the flowmeter.
- Maximum pipe diameter mismatch should not exceed:
 - 1 mm (0.04 inch) for diameters < DN 200 (8")
 - 3 mm (0.12 inch) for diameters ≥ DN 200 (8")
- New installations should be free of metallic and abrasive particles to prevent damage to the sensing elements on start-up

For further information please refer to ISO 14511.



3.3 INSTALLATION STEPS

- The base of thermal flowmeter



IMPORTANT NOTE!

No welding in explosive environment



Carry out the welding operation in accordance with the requirements of special environment.

When installing, place the base on the top of pipe, and make the through-hole of base be perpendicular to axis of pipe. The good welding location of base and welding process is as below.

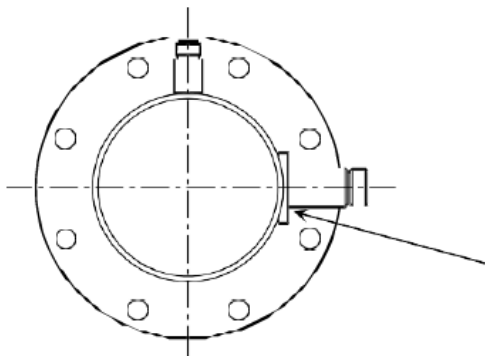

Before Welding, the base should be processed as the same as the circular arc of pipe to ensure sealing

Good welding location of base

THE INSTALLATION OF STANDARD INSERTION TYPE

- Identify an appropriate location for the flow meter.
- Confirm the inner diameter and wall thickness of pipe
- Place the other part of meter into ball valve, and calculate the insertion depth according to the inner diameter and wall thickness of pipe. This step doesn't need to screw the nut by hand.
- Turn the connecting rod of sensor to make the mark direction of sensor as the same flow direction.
- According the calculated data on site, ensure the insertion depth by corresponding calibration on the connecting rod, and then screw the nut tightly.
- If the meter is horizontal installation, the display of the meter can be installed in the direction of 90°, 180° or 270° to meet various requirements.

THE INSTALLATION OF HOT-TAPPED INSERTION TYPE

- Before installation, please conform the connection type and install fittings.
- Before installation, the site must be shut down, and strictly follow the rules of factory.
- Identify an appropriate location for the flow meter.
- According to length requirement of meter, cut the pipe, and install the flanges and bolts on the pipe.
- Ensure the mark direction of meter is as the same flow direction, the display is perpendicular to horizontal plane, the axis of pipeline is paralleled to horizontal plane, the error can't be more than ± 2.5 , and then fix the meter by bolts.



4. ELECTRICAL CONNECTIONS

4.1 SAFETY INSTRUCTIONS



DANGER!

Only when power is switched off, can we do all the work about electrical connections. Please pay all attention to the power supply on the name plate!



DANGER!

Observe the national regulations for electrical installations!



DANGER!

For devices used in hazardous areas, additional safety notes apply; please refer to the Ex documentation.



WARNING!

Observe without fail the local occupational health and safety regulations. Any work done on the electrical components of the measuring device may only be carried out by properly trained specialists.



INFORMATION!

Look at the device nameplate to ensure that the device is delivered according to your order. Check for the correct supply voltage printed on the nameplate.



INFORMATION!

Connect the cable on connector with similar numeral marking

4.2 INSTRUCTION OF SENSOR WIRINGS

1	2	3	4
RT1	RT2	RH1	RH2

Temperature sensor (pt1000)

Heater (pt20)



WARNING!

No operation when the meter is working



WARNING!

Confirm the power supply type



4.3 INSTRUCTION OF TRANSMITTER WIRINGS

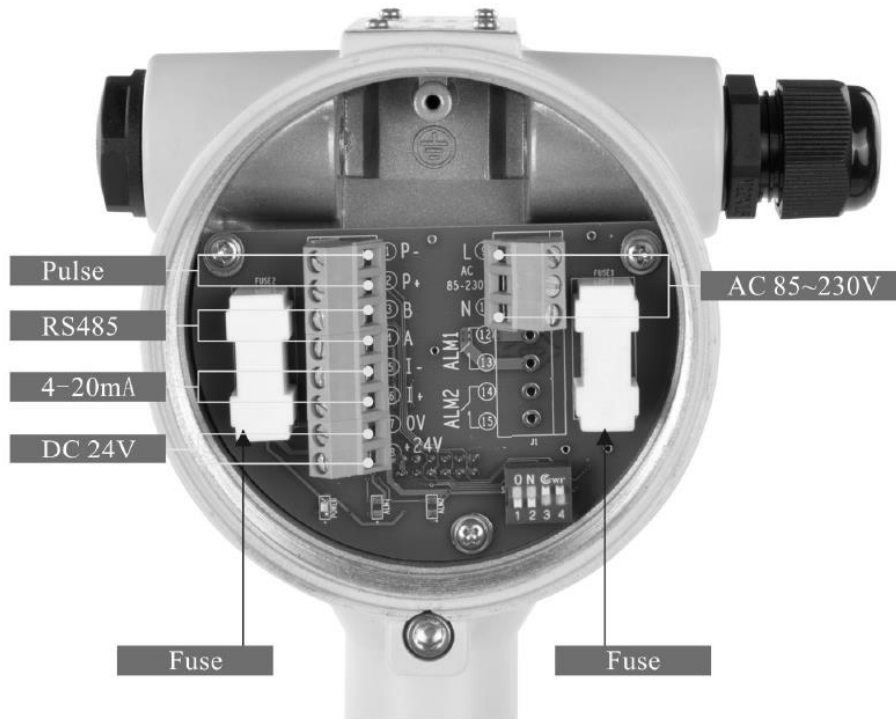

4.4 THE WIRINGS OF POWER SUPPLY

DC POWER SUPPLY

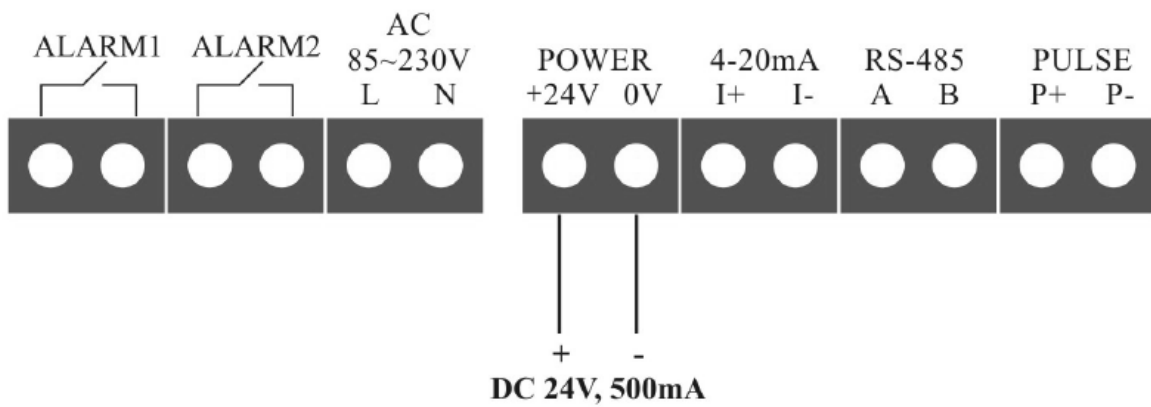



4.5 THE WIRING OUTPUT

❖ THE WIRINGS OF RS485 OUTPUT

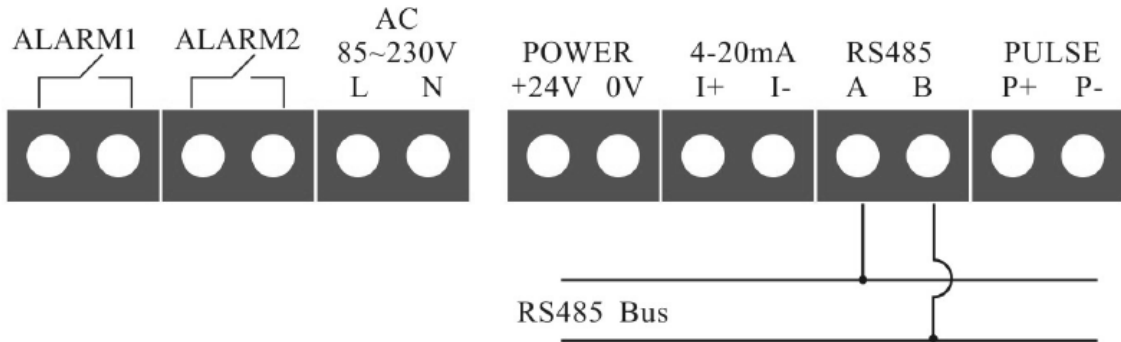

❖ THE WIRINGS OF PULSE OUTPUT

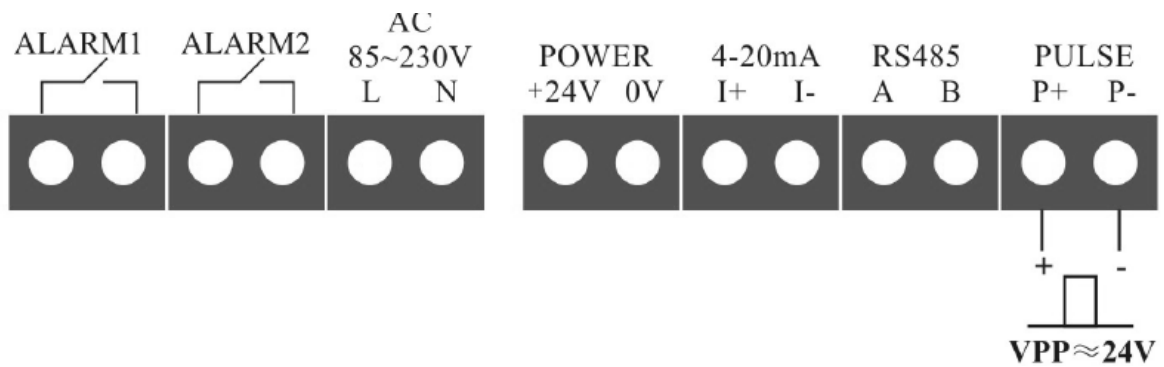

❖ THE WIRINGS OF ALARM OUTPUT

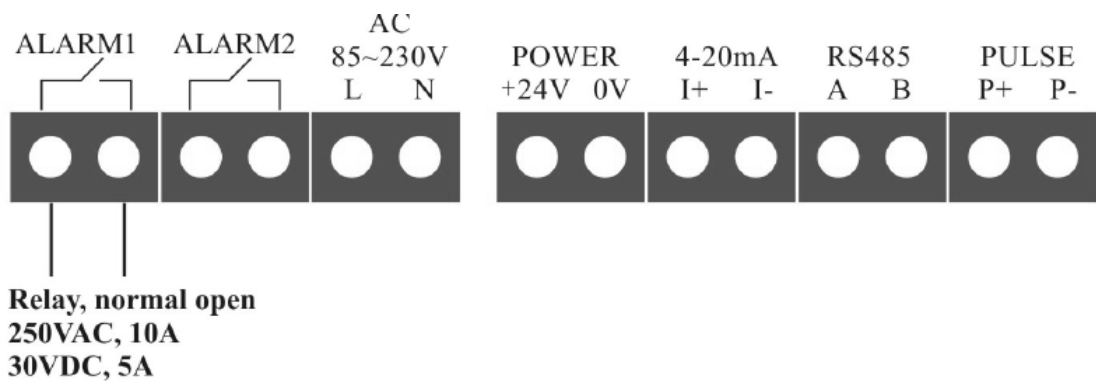



5 OPERATION

5.1 DISPLAY

The display of meter in working status is shown as below.

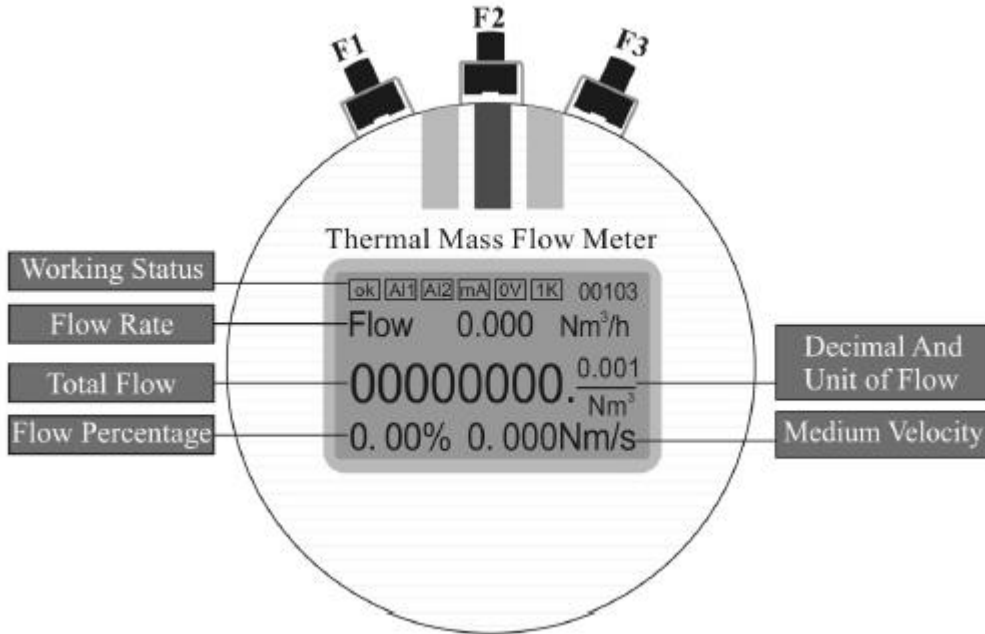

THE PROMPT LINE

OK: The meter can do self-checking. If the system is normal after self-checking, it will display OK, else it will display ERR. The error information can be checked in "Self-Test" set-up menu.

All : Alarm information. AL1 means path 1 alarming, and AL2 means path 2 alarming

mA: If the current output is more than 20mA, it displays mA, else it will be blank.

OV: If the operation parameters overflow, it displays OV, else it will be blank.

UK: For convenience of display and read, when the total flow is more than 10 000 000, it displays 1K, and the is the display total flow multiplied by 1000.

00103: Information of communication status. The first three digits indicate meter address; the forth digit indicates parity check (0: none; 1: odd; 2: even); and the fifty digits indicate baud rate (0: 1200; 1: 2400; 2: 4800; 3: 9600). If the meter address is 1, no parity check, and the baud rate is 9600, it will display "00103".

After powering on, the meter will do self-checking. If the system is normal after self-checking it will display OK, else it will display ERR. The error information can be checked in "Self-Test" set-up menu.

When the meter works fine or after powering on, the meter will do self-checking. If the system is abnormal after self-



checking, the meter will display the submenu of error self-checking (Details in self-Checking menu). 1~2 seconds later, the meter will enter the main menu automatically. Else the meter will enter the main menu directly.

The meter has three function keys: F1, F2 and F3. F1 is Shift Key, F2 is Enter/Next Key, and F3 is Modify Key. (If there are some special functions of keys, please follow the instruction below the LCD)

5.2 PARAMETERS SETUP

HOME PAGE

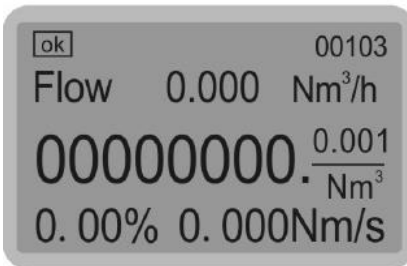

In Home Page, press F2 to enter Main menu. In Main menu, press F2 to enter Sub menu.

MAIN MENU

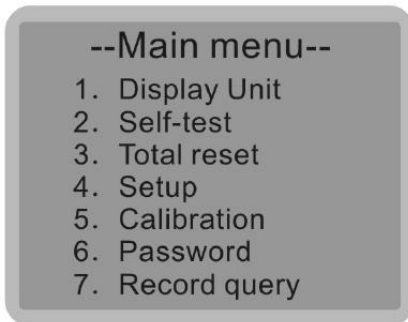

In main menu, press F2 to enter sub-menu menu In setup menu.F1 could be used to move cursor from item 1 to 7

UNIT DISPLAY

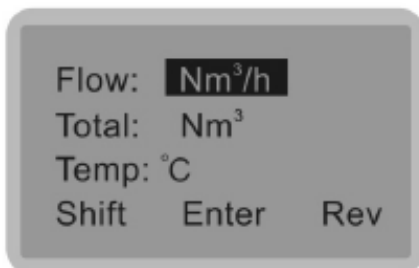

In setup menu, press F1 to select "Unit Display", and press F2 to enter. Press F1 to select the unit of flow or total, and press F3 to modify the unit.

Flow: The unit of flow rate. The unit can be selected Nm3/h, Nm3/min, NI/h, NI/min, t/h, t/min, kg/h and kg/min.

Total: The unit of total flow. The unit can be selected Nm3, NI, t and kg. Select the needed unit, and then press F2 Enter key, the main menu will display with the selected unit.



SELF-CHECKING

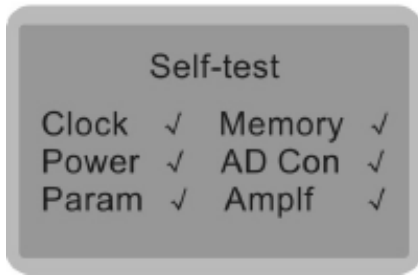

In Main menu, press F1 to select “Self Checking”, and press F2 to enter.

If the meter display ERR in main menu, press enter this submenu to check the details of running status, ✓ is ok, and × means this option is abnormal.

After powering on, the meter will do self-checking. If there are one or some abnormal options, the meter will display the self-test menu. When the meter is running, user can enter this menu to check the running status of flow meter.

TOTAL RESET

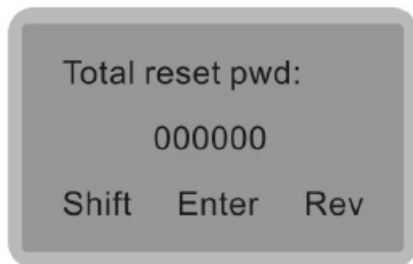

In Main menu, press F1 to select “Total Reset”, and press F2 to enter. Press F1 to password, input reset password (default password is 000000), press F1 to shift digit, and press F3 to change the digit’s number.

After inputting password, press F2 to enter total flow reset submenu.

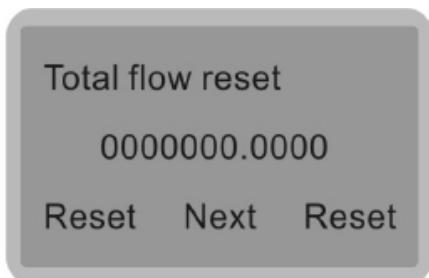

In order to prevent error operation, press F1 and F3 keys at the same time to do total reset. After finishing total reset, the display shows 0000000.0000.

In this sub-menu, press F2 key to enter running time reset.

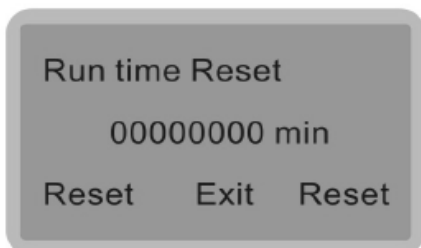

The unit of running time is minute. The largest time is with 8 digits, and the reset operation is as the same as total reset. After resetting, press F2 key to return main menu.



SETUP

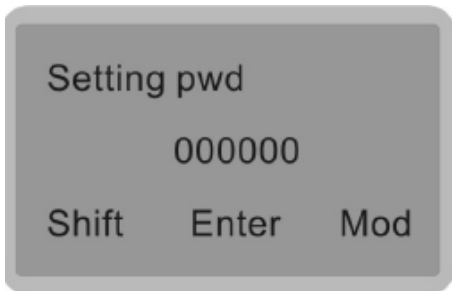

In setup menu, press F1 to select “Parameter Setup”, and press F2 to enter.

Input reset password (default password is 000000), press F1 to shift digit, and press F3 to change the digit's number.

After inputting password, press F2 to finish password setup.



Pipe Diameter is used to input the inner diameter of pipe. The unit is mm.

The range is 0000.000~9999.999.

Press F2 to enter Flow cut-off.

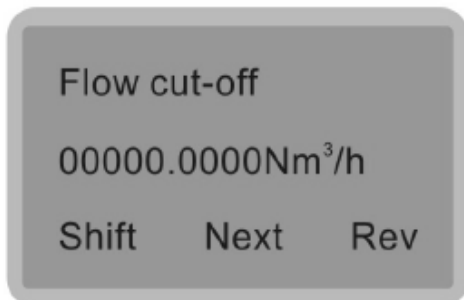

Cut-off. Cut off the low flow according to the actual situation, and the unit is the same as flow rate.

The range is 0000.0000~9999.9999.

Press F2 to enter Damping time.

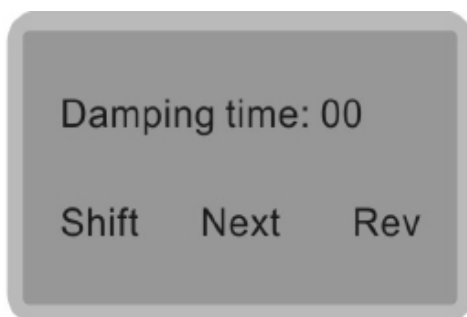

If the flow has a big fluctuation, increase this value to get a stable reading.

The range is 0~32, 0 means no filter.

Press F2 to enter Std Density.



Std density:

1.0000 Kg/m³

Shift Next Rev

Density in Standard Condition.
(20°C, 101.325KPa).
That is used for flow rate display.

Medi: 00

Air

F Factor: 01.0000

Shift Next Rev

Set the medium based on the actual medium in pipe.
The meter contains the conversion coefficient of 59 gases,
if the medium is mixed gas, it needs to calculate the factor.

The density and Factor F of common gas are shown in appendix 2.
Press F2 to enter Meter factor.

Meter factor:

1.0000

Shift Next Rev

Flow Meter factor = standard flow / instrument display flow; Press
F2 to enter Full Scale Flow

Output sel: Flow

Set scale: Nm³/h

0000000.000

Shift Next Rev

The The current output: could be set in the menu:instatenous flow and
velocity of flow can be selected.

The instantaneous flow unit: Nm³/h, velocity of flow unit: Nm/s.
Move the cursor to the flow, use F3 to modify the velocity, move the
cursor by F1 key, use F3 key to change the value.

Scale range is equal to the output of 4-20 mA for flow meter.
Measure Scale could refer to Appendix 3
The range of effective range: 0 ~ 9999999.999.

Device ID: 001

Baud rate: 9600

Parity: None

Shift Next Rev

RS485 communication setup.

The flow meter's address range: 0~255. Baud rate can be selected
1200, 2400, 4800 and 9600. Parity check can be selected none, odd
and even.



Pulse Out: Plus/ Equi
Freq: 0000-5000Hz
F.S: 0000100.000

Shift Next Rev

If Pulse output set as Plus,it means Frequency output.
The Frequency and scale could be se as need

Pulse out: Equi
Unit: Nm³
Coe: 0000.0000

Shift Next Rev

If choose Equi it means pulse output, user could set pulse unit, pulse scale as need.

Alarm 1: Flow high
S.V : +000000.000
Hyst: 000.000

Shift Next Rev

Alarm 1

Set the alarm of flow High, Flow low, Temp high,Temp low

Volume high,Volume low and None.
SV is used to set the alarm value.

The difference value can make the alarm Vibration within controllable range,but this method will reduce the control precision at the same time.
Set this value according to application and experience.

Alarm 2: Flow high
S.V : +000000.000
Hyst: 000.000

Shift Next Rev

Path 2 alarm. The setup is the same as path 1 alarm.

Clock setup:
2012-05-16
09:13:29

Shift Next Rev

The date and time affect the data query and saving. Therefore, set the date and time before recording data.



CALIBRATION

The parameters in this submenu are very important. In order to prevent unauthorized operation or wrong operation, it needs to input password before entering this submenu.

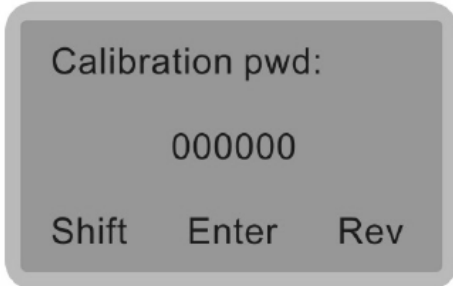

In setup menu, press F1 to select “Calibration”, and press F2 to enter. The default password is 00000. Press F2 to enter AD zero.

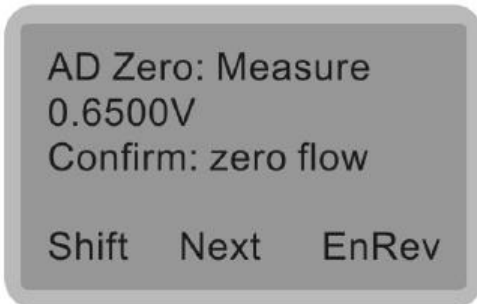

Zero voltage value is used to set the voltage value while the flow rate is 0. Before calibration, confirm the flow in pipe is zero, and waiting for more than 30s to steady the flow. Press F1 and F3 keys at the same time until the meter displays success. This value is can be input manually. Press F3 to select “Input”, input this value manually, and then press F2 to enter R value.

Note: Don't input zero voltage value when the meter is running with flow in pipe.

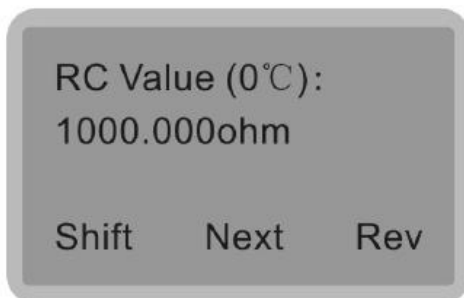

The resistance value is used to input the resistance value of temperature sensor.

Press F2 to enter velocity table.

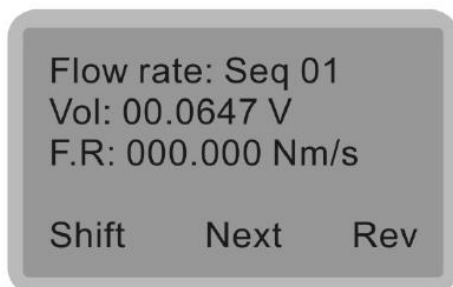

Flow rate . Set the voltage and velocity in more than 40 sections. After calibration, Input the voltage and velocity from small section to large section.

Press F2 to enter flow correction.

Note: The meter calculates the flow by velocity table. Please don't modify the data in the table.



PASSWORD

In this submenu, it can modify the password of total reset, setup and calibration.

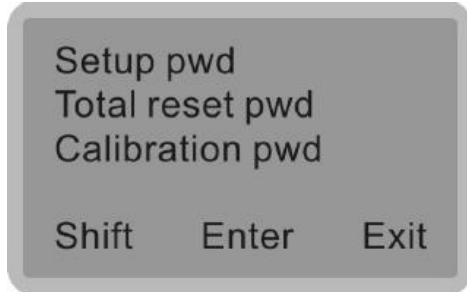

Setup pwd: Setup menu set password;
Total reset pwd : Clear total flow password;
Calibration Pwd: Calibration menu password

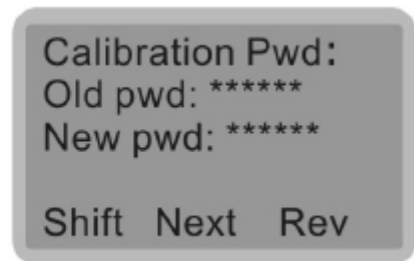
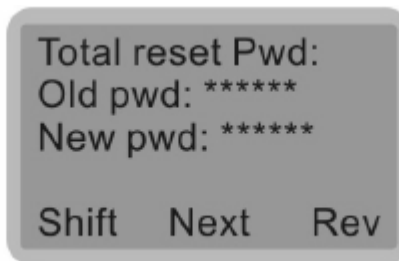
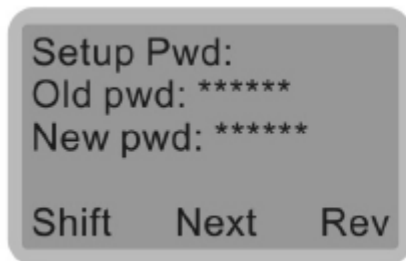

After inputting old and new passwords, Press F2 to save setup, the LCD will display “Success”, and then return to main menu.

QUERY

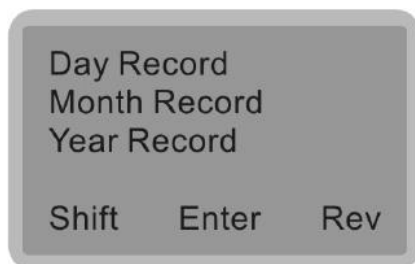

In setup menu, press F1 to select “Query”, and then press F2 to enter.

In query submenu, there are day, month and year records.



In query submenu, press F1 to select Day Record, and then press F2 to enter.

In Day Record, press F1 to shift cursor position, and press F3 to modify the date.

For example, the “80.03 Nm³” is the totalizer on April 2th, 2012. The method of querying Month and Year Records is the same as querying Day Record.



Appendix 1 The Density and Conversion Coefficient of Common Gas

At present, the laboratory cannot calibrate the flow meter according to the gas actually used by the user on working site, and the calibration is usually carried out after convert the flow medium to air. The conversion of different gases is made through the conversion coefficient, and the conversion coefficient of a single component gas can be found in the table. The following table:

Table 1 The Density and Conversion Coefficient of Common Gas

	Gas	Specific Heat(Kal/g*°C)	Density (g/l,0°C)	Conversion Coefficient
0	Air	0.24	1.2048	1.0000
1	Argon (Ar)	0.125	1.6605	1.4066
2	Arsine (AsH ₃)	0.1168	3.478	0.6690
3	Boron Tribromide (BBr ₃)	0.0647	11.18	0.3758
4	Boron Trichloride (BCl ₃)	0.1217	5.227	0.4274
5	Boron Trifluoride (BF ₃)	0.1779	3.025	0.5050
6	Borane (B ₂ H ₆)	0.502	1.235	0.4384
7	Carbon Tetrachloride (CCl ₄)	0.1297	6.86	0.3052
8	Carbon Tetrafluoride (CF ₄)	0.1659	3.9636	0.4255
9	Methane (CH ₄)	0.5318	0.715	0.7147
10	Ethylene (C ₂ H ₄)	0.3658	1.251	0.5944
11	Ethane (C ₂ H ₆)	0.4241	1.342	0.4781
12	Allylene (C ₃ H ₄)	0.3633	1.787	0.4185
13	Propylene (C ₃ H ₆)	0.3659	1.877	0.3956
14	Propane (C ₃ H ₈)	0.399	1.967	0.3459
15	Butyne (C ₄ H ₆)	0.3515	2.413	0.3201
16	Butene (C ₄ H ₈)	0.3723	2.503	0.2923
17	Butane (C ₄ H ₁₀)	0.413	2.593	0.2535
18	Pentane (C ₅ H ₁₂)	0.3916	3.219	0.2157
19	Carbinol (CH ₃ OH)	0.3277	1.43	0.5805
20	Ethanol (C ₂ H ₅ OH)	0.3398	2.055	0.3897
21	Trichloroethane (C ₂ HCl ₃)	0.1654	5.95	0.2763
22	Carbon Monoxide (CO)	0.2488	1.25	0.9940



23	Carbon Dioxide (CO ₂)	0.2017	1.964	0.7326
24	Cyanide (C,N,)	0.2608	2.322	0.4493
25	Chlorine (Cl ₂)	0.1145	3.163	0.8529
26	Deuterium (D ₂)	1.7325	0.1798	0.9921
27	Fluoride (Fi)	0.197	1.695	0.9255
28	Germanium Tetrachloride (GeCl ₄)	0.1072	9.565	0.2654
29	Germane (GeH ₄)	0.1405	3.418	0.5656
30	Hydrogen (H,)	3.4224	0.0899	1.0040
31	Hydrogen Bromide (HBr)	0.0861	3.61	0.9940
32	Hydrogen Chloride (HCl)	0.1911	1.627	0.9940
33	Hydrogen Fluoride (HF)	0.3482	0.893	0.9940
34	Hydrogen Iodide (HI)	0.0545	5.707	0.9930
35	Hydrogen Sulfide (H ₂ S)	0.2278	1.52	0.8390
36	Helium (He)	1.2418	0.1786	1.4066
37	Krypton (Kr)	0.0593	3.739	1.4066
38	nitrogen (N,)	0.2486	1.25	0.9940
39	Neon (Ne)	0.2464	0.9	1.4066
40	Ammonia (NH ₃)	0.5005	0.76	0.7147
41	Nitric Oxide (NO)	0.2378	1.339	0.9702
42	Nitrogen Dioxide (NO ₂)	0.1923	2.052	0.7366
43	Nitrous Oxide (N ₂ O)	0.2098	1.964	0.7048
44	Oxygen (O ₂)	0.2196	1.427	0.9861
45	Phosphorus Trichloride (PCl ₃)	0.1247	6.127	0.3559
46	Phosphorane (PH ₃)	0.261	1.517	0.6869
47	Phosphorus Pentafluoride (PF ₅)	0.1611	5.62	0.3002
48	Phosphorus Oxychloride (POCl ₃)	0.1324	6.845	0.3002
49	Silicon Tetrachloride (SiCl ₄)	0.127	7.5847	0.2823
50	Silicon Fluoride (SiF ₄)	0.1692	4.643	0.3817
51	Silane (SiH ₄)	0.3189	1.433	0.5954
52	Dichlorosilane (SiH ₂ Cl ₂)	0.1472	4.506	0.4095
53	Trichlorosilane (SiHCl ₃)	0.1332	6.043	0.3380
54	Sulfur Hexafluoride (SF ₆)	0.1588	6.516	0.2624



55	Sulfur Dioxide (SO ₂)	0.1489	2.858	0.6829
56	Titanium Tetrachloride (TiCl ₄)	0.1572	8.465	0.2048
57	Tungsten Hexafluoride (WF ₆)	0.0956	13.29	0.2137
58	Xenon (Xe)	0.0379	5.858	1.4066



Appendix 2 Upper Range Value of Common Gas

(Unit: Nm³/h. The follow table can be extended)

Nominal Diameter (mm)	Air	Nitrogen(N ₂)	Oxygen(O ₂)	Hydrogen(H ₂) 10
15	65	65	32	10
25	175	175	89	28
32	290	290	144	45
40	450	450	226	70
50	700	700	352	110
65	1200	1200	600	185
80	1800	1800	900	280
100	2800	2800	1420	470
125	4400	4400	2210	700
150	6300	6300	3200	940
200	10000	10000	5650	1880
250	17000	17000	8830	2820
300	25000	25000	12720	4060
400	45000	45000	22608	7200
500	70000	70000	35325	11280
600	100000	100000	50638	16300
700	135000	135000	69240	22100
800	180000	180000	90432	29000
900	220000	220000	114500	37807
1000	280000	280000	141300	49120
1200	400000	400000	203480	69972
1500	600000	600000	318000	105200

The flow rate in standard condition: The flow rate is in the condition of 20°C temperature and 101.325kPa pressure .

The unit of flow rate is optional: Nm³/h, Nm³/min, L/h, L/min, t/h, t/min, kg/h or kg/min.

The reduction formula of flow rate in working condition and flow rate in standard condition :

$$Q_s = 0.101325 + p * 273.15 + 20 \cdot 0.10325 \cdot 273.15 + t$$

Q_s: The flow rate in standard condition (Nm³/h). Q_n: The flow rate in working condition (m³/h).

t: The medium temperature in working condition (°C).

p: The medium pressure in working condition (Gauge pressure, Mpa).



MIAL[®]
INSTRUMENTS PVT.LTD.
Measuring & Beyond

USA OFFICE ADDRESS

MIAL INSTRUMENTS PVT. LTD.
Downtown Republic Center
325 N. St.Paul Street, Suite 3100
Dallas 75201, Texas, USA

FACTORY ADDRESS

MIAL INSTRUMENTS PVT. LTD.
856/ 6 GIDC
Makarpura, Vadodara 390010, Gujarat, India
+91-9913449547/9913449548

Email : info@mialinstruments.com
www.mialinstruments.com



**MIAL
INSTRUMENTS**

Measuring & Beyond

856/6, GIDC MAKARPURA, VADODARA - 390010

Phone : +91-9913449547 / +91-9913449548

E-MAIL : info@mialinstruments.com

WWW : www.mialinstruments.com