

| INSTALLATION & OPERATION MANUAL

MUF 1200/MUF(B)1200 (1%) Clamp on Ultrasonic Flow/BTU Meter



MIAL[®]
INSTRUMENTS PVT.LTD.
Measuring & Beyond

www.mialinstruments.com

MUF 1200(1%)

Clamp on Ultrasonic Flow & BTU Meter

Preface

- Thank you for purchasing our product.
- This manual is about the various functions of the product, wiring methods, setting methods, operating methods, troubleshooting methods, etc.
- Please read this manual carefully before operation, use this product correctly to avoid unnecessary losses due to incorrect operation.
- After you finish reading, please keep it in a place where it can be easily accessed at any time for reference during operation.



NOTE!

Modification of this manual's contents will not be notified as a result of some factors, such as function upgrading. We try our best to guarantee that the manual content is accurate, if you find something wrong or incorrect, please contact us. The content of this manual is strictly prohibited from reprinting or copying.

About this manual

- Please submit this manual to the operator for reading.
- Please read the operation manual carefully before installing the instrument. On the precondition of full understanding.
- This manual only describes the functions of the product. The MIAL Instruments pvt.ltd. does not guarantee that the product will be suitable for a particular application.

Warnings and symbols used



HAZARD!

If not taken with appropriate precautions, will result in serious personal injury, product damage or major property damage.



WARNING!

Pay special attention to the important information linked to product or particular part in the operation Manual



CAUTION!

Disregarding these instructions can result in damage to the device or to parts of the operator's plant.



INFORMATION!

These instructions contain important information for the handling of the device.



Table of Contents

PREFACE	1
ABOUT THIS MANUAL	1
1. INTRODUCTION	4
1.1 PURPOSE OF THE MANUAL	4
1.2 OPERATING PRINCIPLE	5
1.3 TECHNICAL SPECIFICATIONS.....	6
2. DEVICE DESCRIPTION	7
2.1 SCOPE OF DELIVERY	7
2.2 NAMEPLATES.....	8
3. INSTALLATION	10
3.1 SITE SELECTION	10
3.1.1 BASIC RECOMMENDATIONS.....	10
3.1.2 FLOW DIRECTION	10
3.1.3 INSTALLATION OF REMOTE MOUNT TRANSMITTER.....	10
3.1.4 STRAIGHT LENGTH REQUIREMENT.....	11
3.2 MECHANICAL INSTALLATION.....	12
3.2.1 STANDARD TRANSMITTER DIMENSION.....	12
3.2.2 TRANSDUCER INSTALLATION.....	12
3.2.3 TRANSDUCER SPACING.....	13
3.2.4 TRANSDUCER MOUNTING METHODS.....	13
3.2.5 V METHOD.....	13
3.2.6 Z METHOD.....	14
3.3 WARNINGS.....	16
4 ELECTRICAL CONNECTIONS.....	17
4.1 SAFETY INSTRUCTIONS.....	17
4.2 WIRE CONNECTING.....	17
4.2.1 POWER SUPPLY OPTION.....	17
4.2.2 TRANSMITTER WIRING.....	18
4.3 POWERING ON.....	20
4.4. KEYPAD FUNCTIONS.....	21
4.5 KEYPAD OPERATION.....	21
5 OPERATION.....	22
5.1 BASIC SETTINGS.....	22
5.2 SYSTEM NORMAL IDENTIFICATION.....	23
5.3 LOW FLOW CUTOFF VALUE.....	23
5.4 LOW FLOW CUTOFF VALUE.....	24
5.5 SCALE FACTOR.....	24
5.6 SYSTEM LOCK.....	24
5.7 4 ~ 20MA CURRENT LOOP OUTPUT	24



5.8 FREQUENCY OUTPUT	25
5.9 TOTALIZER PULSE OUTPUT.....	25
5.10 ALARM PROGRAMMING.....	26
5.11 4-20MA ANALOG OUTPUT CALIBRATION.....	26
5.12 ESN	26
6 WINDOWS DISPLAY EXPLANATION.....	27
6.1 WINDOWS DISPLAY CODES	27
6.2 DISPLAY EXPLANATIONS.....	29
7 ERROR DIAGNOSES.....	50
7.1 FREQUENTLY ASKED QUESTIONS AND ANSWERS.....	51
APPENDIX 1 – COMMUNICATIONS PROTOCOL	53
Appendix 2- FLOW APPLICATION DATA	59
Appendix 3- SOUND VELOCITY IN WATER (1 ATM) AT DIFF TEMP.....	59



1. INTRODUCTION

1.1 PURPOSE OF THE MANUAL

Overview:

Welcome to the user manual for the Mial MUF 1200 - Clamp on Ultrasonic Flow /BTU meter(1%). . This comprehensive guide is designed to assist operators, maintenance personnel, and system integrators in understanding, installing, operating, and maintaining the Mial MUF 1200 - Clamp on Ultrasonic Flow /BTU meter(1%) effectively.

Objectives:

Clarification of Functionality: This manual aims to provide a clear understanding of the principles and functionality of the Mial MUF 1200 - Clamp on Ultrasonic Flow /BTU meter(1%). Users will gain insights into its design, components, and how it precisely measures fluid flow.

Guidance for Installation:

Step-by-step instructions and considerations for proper installation are provided to ensure optimal performance. Safety precautions are emphasized to create a secure working environment.

Training and Familiarization:

Users will be guided through the features, controls, and indicators of the Flow /BTU meter, facilitating efficient operation. This section aims to serve as a valuable training resource for users at various experience levels.

Maintenance and Troubleshooting Assistance:

Learn about routine maintenance procedures and effective troubleshooting techniques. This manual empowers users to address common issues and perform regular maintenance to enhance the longevity of the Mial MUF 1200 - Clamp on Ultrasonic Flow /BTU meter(1%). .

Intended Audience:

This manual is intended for operators, maintenance personnel, and system integrators involved in the installation, operation, and maintenance of the Mial MUF 1200 - Clamp on Ultrasonic Flow /BTU meter(1%). . It is suitable for both novice users seeking basic guidance and experienced professionals looking for specific details.

Important Notes:

Please read through the manual carefully, adhering to safety guidelines and following instructions precisely. If any uncertainties arise during the installation, operation, or maintenance processes, seek assistance from qualified personnel or our customer service / support team.

Reference to Other Documentation:

Refer to the accompanying technical specifications document for in-depth details about the Mial MUF 1200 - Clamp on Ultrasonic Flow /BTU meter(1%). . Additional resources can be found on our website.



Intended use



CAUTION!

Responsibility for the use of the measuring devices with regard to suitability, intended use and corrosion resistance of the used materials against the measured fluid lies solely with the operator.



INFORMATION!

The manufacturer is not liable for any damage resulting from improper use or use for other than the intended purpose

Certification



The manufacturer certifies successful testing of the product by applying the CE marking



The manufacturer certifies successful testing of the product by applying the ISO marking

1.2 OPERATING PRINCIPLE

Mial MUF 1200 Clamp on Ultrasonic Flow meter (1%) works on the transit time Principle.

The transit-time method relies on the difference in the time it takes for ultrasonic pulses to travel with and against the flow of a fluid inside a pipe.

Two transducers (labeled Transducer A with up arrow and Transducer B with tail arrow) are mounted on the outside of the pipe, either on the same side (V-method) or opposite sides (Z-method). They alternate between sending and receiving ultrasonic pulses through the fluid.

Pulses with and against the flow:

With Flow: When a pulse is transmitted by Transducer A and received by Transducer B, the flow of the fluid helps the pulse travel faster.

Against Flow: When a pulse is transmitted by Transducer B and received by Transducer A, the flow of the fluid slows down the pulse.

The difference in the transit times of the two pulses (one with the flow and one against it) is proportional to the flow velocity of the fluid. This time difference is used to calculate the velocity of the fluid.



1.2 TECHNICAL SPECIFICATIONS*

Operation and performance

Flow measurement

Ultrasonic differential transit-time Technology

Fluid types

Water

Fluid properties

Clean liquids in full (pressurized) pipes

Pipe sizes

25 MM – 1200 MM

Pipe materials

metallic and non-metallic materials.

Flow Range

$\pm 0.09 \text{ft/s} \sim \pm 16 \text{ft/s}$ ($\pm 0.03 \text{m/s} \sim \pm 5 \text{m/s}$)

Flow accuracy (velocity)

$\pm 1\%$ of the measured Value

Achievable with process calibration

Repeatability

$\pm 0.2\%$ of the measured value

Linearity

$\pm 1\%$

Measurement parameters

Flow Meter– Instantaneous flow, totalized flow

Btu meter – Instantaneous energy, totalized energy,
Instantaneous flow, totalized flow, supply temperature and
return temperature.

Certification

Calibration certification, CE, ISO

Electronics

Enclosures

ABS

Wall mounted enclosure

Enclosure IP rating

IP65

Memory

EEPROM

Power supply

24 VDC/2A

Use 2-amp SMPS when employing AC power

Ambient temperature

32°F to 140°F (0°C to 60°C)

Humidity

Up to 99% RH, non-condensing

Standard output

Analog output : 4 to 20 mA ,750 Ω maximum load

Pulse output– 0~10KHz Alarm Relay output

Network Connection

Modbus RTU RS 485

Cable

30ft (9m)

Flow Transducer

Operating Temperature range (Fluid)

Standard: 5°F to 140°F (–15°C to 60°C)

Optional: 5°F to 266°F (–15°C to 130°C)

Process connections

Clamp on/Strap on

Materials

Transducer:ABS

IP rating

IP68

Meter installation orientation

Horizontal or Vertical

In a vertical installation, it is essential that the pipe be fully filled, with the flow direction oriented from bottom to top.

Energy measurement

Temperature sensor PT1000

Standard: –4°F to 176°F (–20°C to 80°C)

Optional: –40°F to 356°F (–40°C to 180°C)

Mountings





Clamp on/Strap on

*Specifications are subject to change without prior notice.



2. DEVICE DESCRIPTION

2.1 SCOPE OF DELIVERY

-  **INFORMATION!**
Do a check of the packing list to make sure that you have all the elements given in the order
-  **INFORMATION!**
Inspect the packaging carefully for damages or signs of rough handling. Report damage to the carrier and to the local office of the manufacturer.
-  **INFORMATION!**
The field device will arrive in one standard cartons. The standard carton contains one small corrugated box containing Transmitter Unit. Also, the standard carton box contains Flow Transducers ,Product documentation, Test Certificates, PT 1000 Temperature sensors (in BTU meter)etc
-  **INFORMATION**
The MUF 1200 transmitters, transducers & PT1000 temperature sensors(in BTU) are components of a uniquely calibrated system and must be installed together as per the serial number. Mixing components from other systems will result in significant calibration errors.The transmitter serial number can be found on the sticker on the side of the electronics enclosure, and the sensor serial number is located on the sticker on the sensor body.

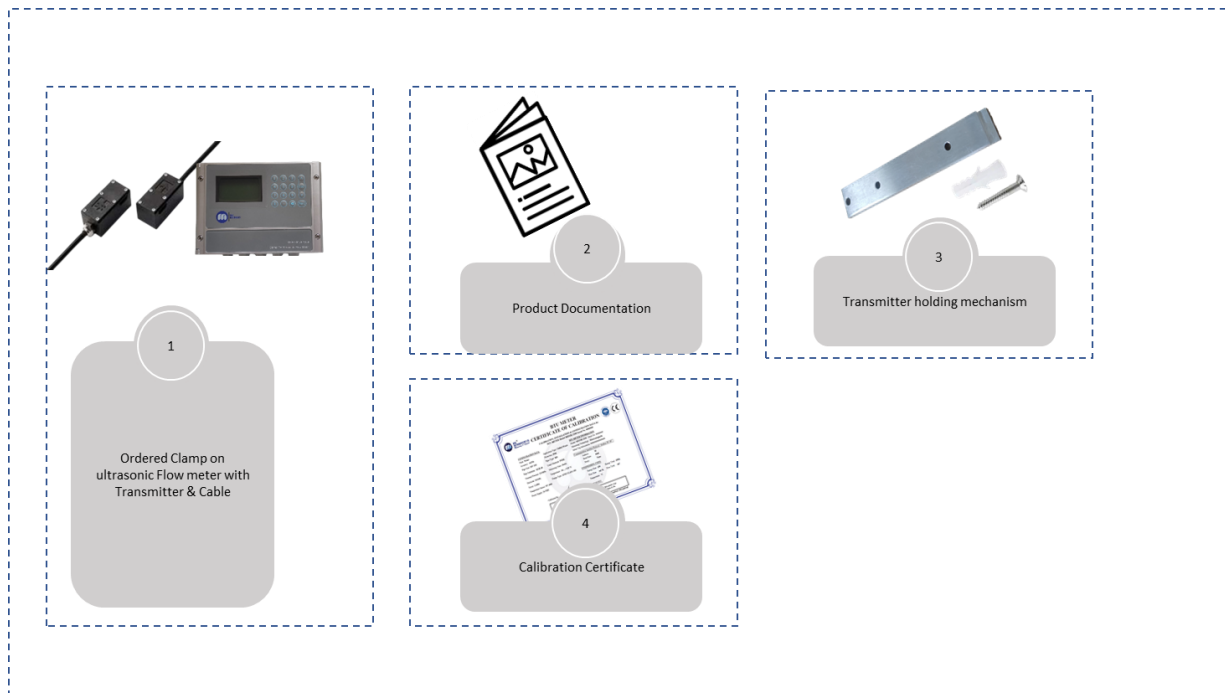

FLOW METER KIT

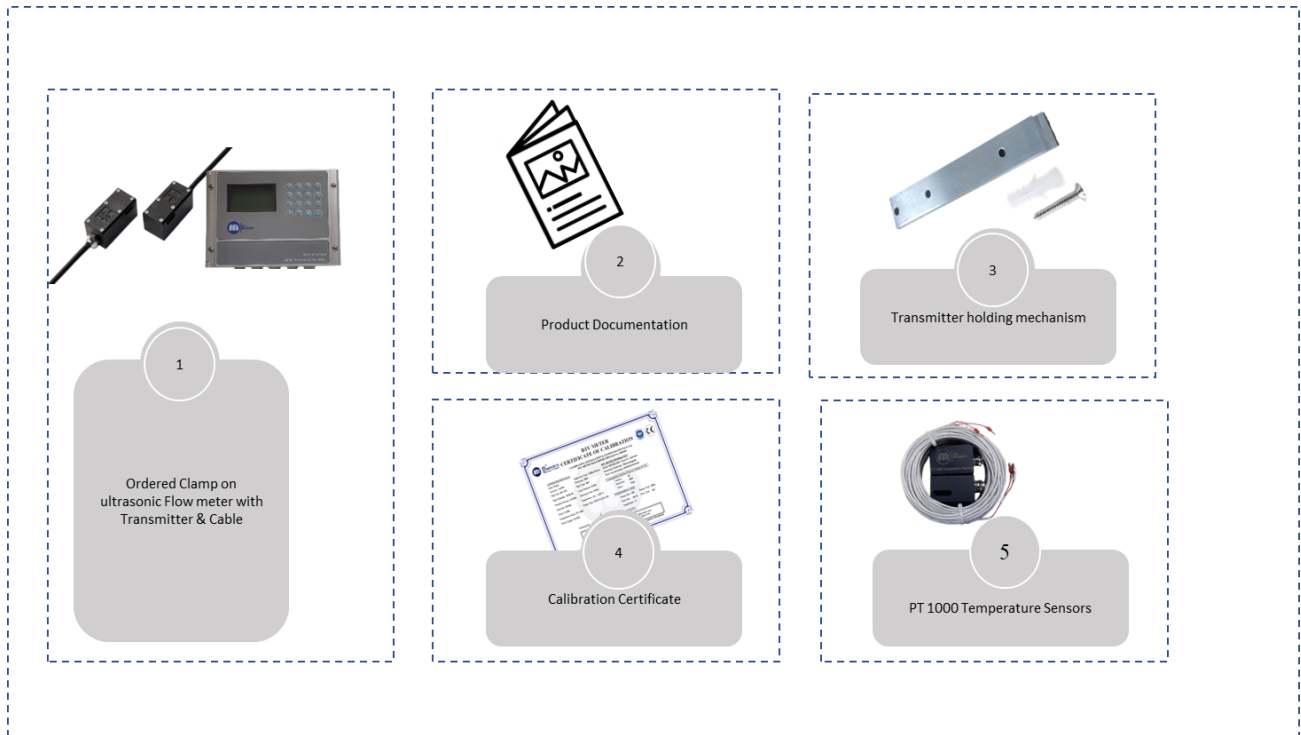



BTU METER KIT

2.2 NAMEPLATES

i **INFORMATION!** Look at the device nameplate to ensure that the device is delivered according to your order. Check for the correct supply voltage printed on the nameplate

NAMEPLATE FOR THE TRANSMITTER (FLOW METER)

<p>Ultrasonic Flow meter</p>	<p>Model: MUF 1200-1(FOR1%) Flow Rate: $\pm 0.03\text{m/s} \sim \pm 5\text{m/s}$ Temp: $0^{\circ}\text{C} - 60^{\circ}\text{C}$ Protection Class: IP65 S/N: XXXXXXXX K Factor: X.XXX</p>
	
	

NAMEPLATE FOR THE TRANSMITTER (BTU METER)

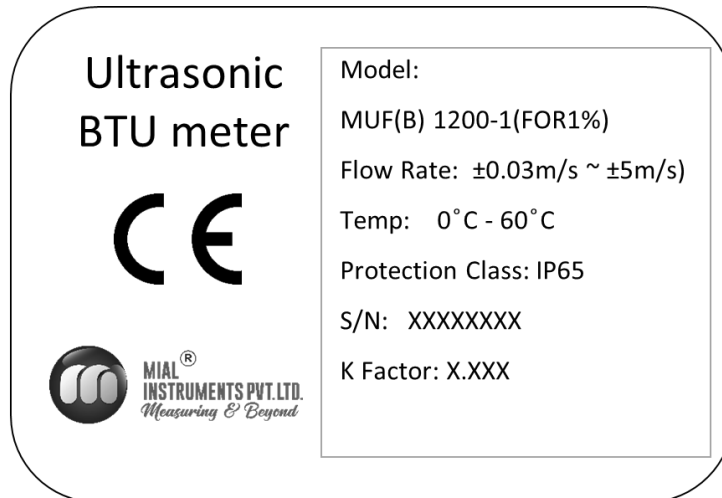

NAMEPLATE FOR THE TRANSDUCER

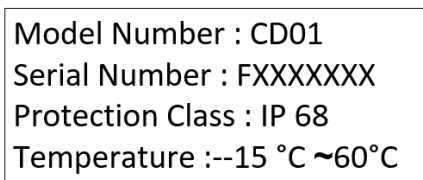



3. INSTALLATION

3.1 SITE SELECTION

When selecting a site for a Flow /BTU meter installation, prioritize accessibility for installation and maintenance. Consider environmental factors like temperature and humidity as per guidelines. Ensure the flow profile is stable and the pipe is in good condition. Safety and ease of access for personnel should also be taken into account to optimize meter performance and longevity.

3.1.1 BASIC RECOMMENDATIONS

In general guidelines, it's recommended to find a location where the pipe has the longest straight segment with a clear run. This ensures smooth laminar flow of the fluid through the meter, which is crucial for accurate measurement. A longer clear run of pipe minimizes disturbances and turbulence that could affect the meter's performance. This approach helps optimize the meter's accuracy and reliability by providing a stable flow profile for measurement.

3.1.2 FLOW DIRECTION

The Mial MUF1200 Flow /BTU meter(1%) should be installed ensuring the arrow indicated on the meter points in the direction of flow. When correctly installed, as illustrated, the arrowhead should align with the flow direction. The transmitter display will indicate positive values corresponding to the flow direction indicated by the arrow. If the fluid flows in the opposite direction to the arrow, the display will show negative readings reflecting the reverse flow direction.



3.1.3 INSTALLATION OF REMOTE MOUNT TRANSMITTER

There is a "Position Drawing" in the packing.

Please use it as a template in the place that you are going to install the Flow /BTU meter(1%). Choose the corresponding to the four mounting holes to drill at the screw position shown on the drawing with the 10 mm drill.

Take out the enclosed screws and make the 4 attaching lugs installed in the position you drill the holes. Insert the plastic bushings into the installing holes. Then put the flow meter into the position and screw it in.

3.1.4 STRAIGHT LENGTH REQUIREMENT

- The installation of this ultrasonic Flow /BTU meter(1%) is the simplest one of all kinds of Flow /BTU meter(1%)s. Only one suitable measuring site needed, plug the transducers on the pipe and then start the measurement.
- When selecting a measurement site, it is important to select an area where the fluid flow profile is fully developed to guarantee a highly accurate measurement. Use the following guidelines to select a proper installation site:
- Choose a section of pipe that is always full of liquid, such as a vertical pipe with flow in the upward direction or a full horizontal pipe.
- Ensure enough straight pipe length at least equal to the figure shown below for the upstream and downstream transducers installation. Try to avoid Ensure enough straight pipe length at least equal to the figure shown below for the upstream and downstream transducers installation.
- On the horizontal pipe, the transducer should be mounted on the 9 and 3 of the pipe, avoiding the position of 6 and 12, in case of the signal attenuation caused by pipe at the bottom sediment or bubble、cavitation on the pipe.
- Ensure that the measuring site temperature is under the transducer temperature limits.
- Consider the inside condition of the pipe carefully. If possible, select a section of pipe where the inside is free of excessive corrosion or scaling.
- Choose a section of sound conducting pipe.

90° Bend

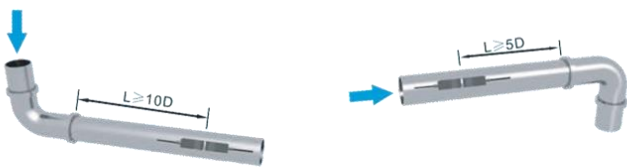

Tee



Diffuser



Reduce

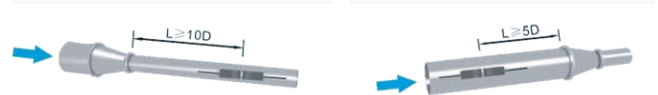

Valve



Vertical

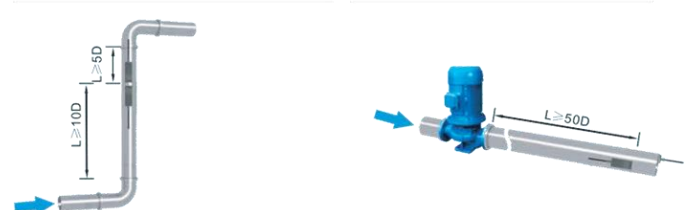



3.2 MECHANICAL INSTALLATION



IMPORTANT NOTE!

MUF 1200 transmitters and transducer are two parts of one uniquely calibrated system and must be installed together as per the serial Number . Mixing components from other systems will result in significant calibration errors.

3.2.1 STANDARD TRANSMITTER DIMENSIONS

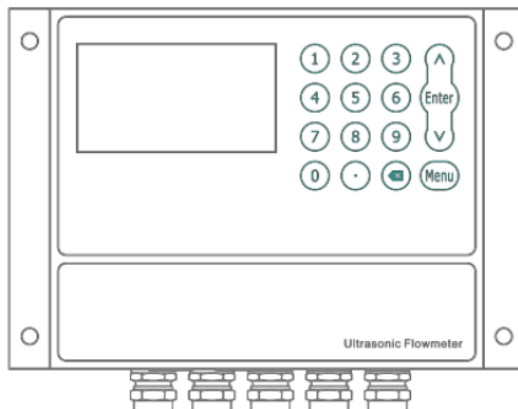

3.2.2 TRANSDUCER INSTALLATION

Please make sure the pipe surface where the transducers are to be mounted are all clean. Including the rust, scale or loose paint to have a smooth surface. Choose the section and don't forget apply the coupling compound. Apply the coupling compound down the center of the face of each transducer as well as on the pipe surface, ensure there are no air bubbles between the transducers and the pipe wall, and then attach the transducers to the pipe with the straps provided and tighten them securely.

Note: The two transducers should be mounted at the pipe's centerline on horizontal pipes. Make sure that the transducer mounting direction is parallel with the flow.

During the installation, there should be no air bubbles or particles between the transducer and the pipe wall. On horizontal pipes, the transducers should be mounted in the 3 o'clock and 9 o'clock positions of the pipe section in order to avoid any air bubbles inside the top portion of the pipe. (Refer to Transducer Mounting). If the transducers cannot be mounted horizontally symmetrically due to limitation of the local installation conditions, it may be necessary to mount the transducers at a location where there is a guaranteed full pipe condition (the pipe is always full of liquid).

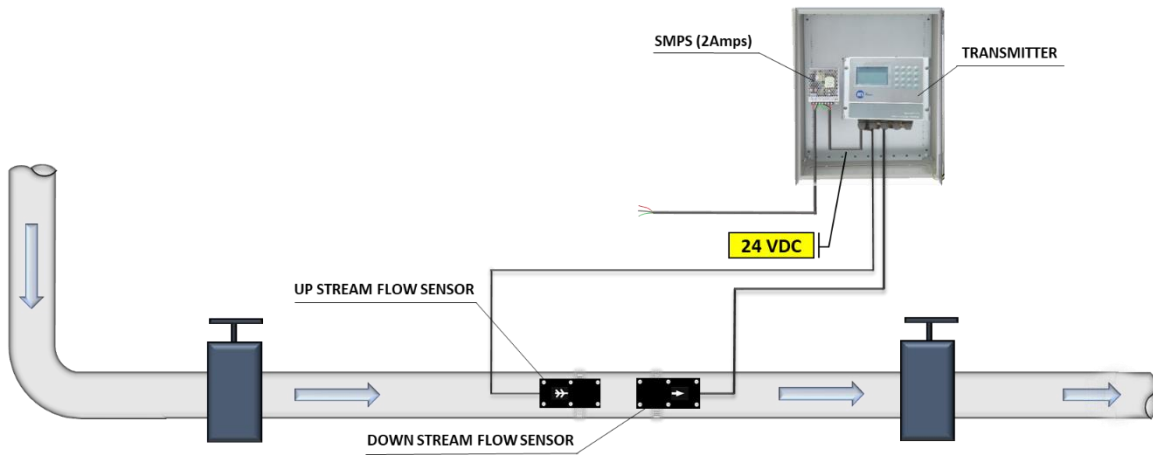

3.2.3 TRANSDUCER SPACING

The spacing between the ENDS of the two transducers is considered as the standard transducer spacing (Refer to MENU14). After entering the required parameters, Check the data displayed in Window M14 and adjusted the transducers spacing according to the data displayed in Windows M14.

3.2.4 TRANSDUCER MOUNTING METHODS

There are two mounting method, you could use depend on the measuring environment. V method and Z method (Reflect method and Direct method).

V method is easy to installation and fit for mostly ultrasonic environment but Z method has stronger signal and works better in the complicated measuring environment.

3.2.5 V METHOD

The V method is considered as the standard method. It is convenient to use, but still requires proper installation of the transducers, contact on the pipe at the pipe's centerline and equal spacing on either side of the centerline.

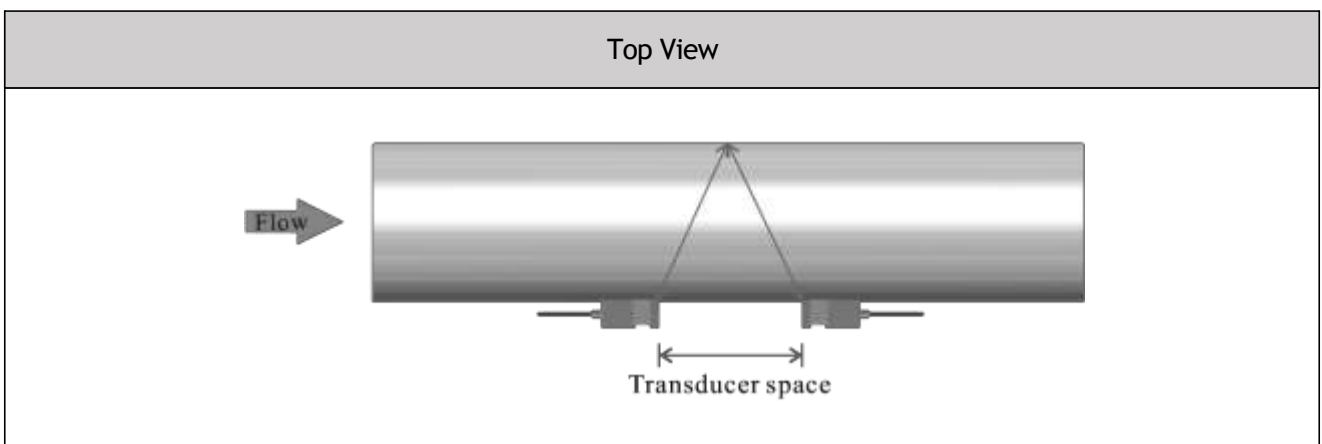

3.2.6 Z METHOD

The signal transmitted in a Z method installation has less attenuation than a signal transmitted with the V method. When the pipes are too large, there are some suspended solids in the fluid, or the scaling and liner are too thick. This is because the Z method utilizes a directly transmitted (rather than reflected) signaling which transverses the liquid only once. The Z method is able to measure on pipe diameters ranging from 100mm to 5000mm (4 inch to 200 inch) approximately. Therefore, we recommend the Z method for pipe diameters over 300mm (12 inch).

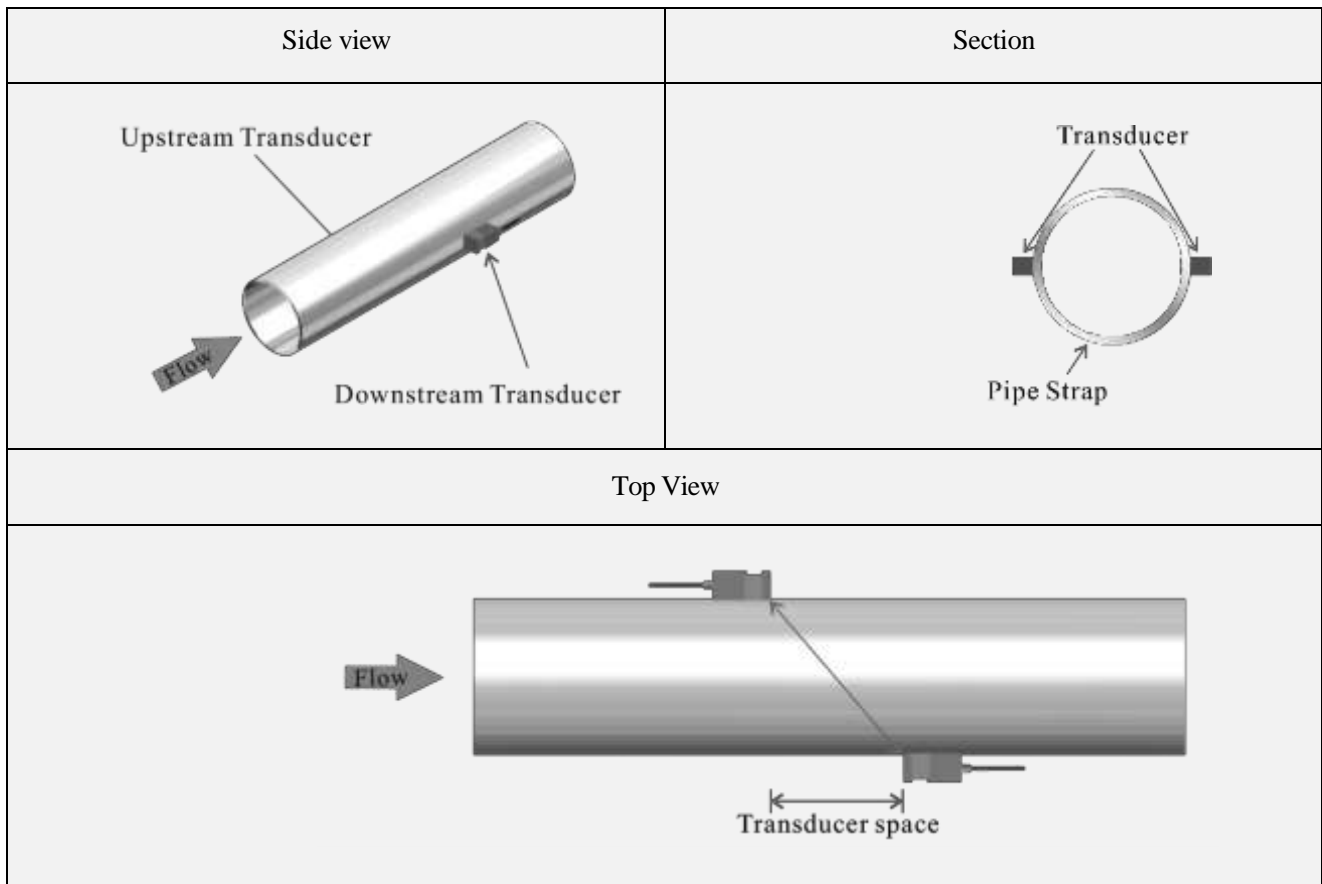

TRANSDUCER MOUNTING INSPECTION

Check to see if the transducer is installed properly and if there is an accurate and strong enough ultrasonic signal to ensure proper operation and high reliability of the transducer. It can be confirmed by checking the detected signal strength, total transit time, delta time as well as transit time ratio.

The "mounting" condition directly influences the flow value accuracy and system long-time running reliability. In most instances, only apply a wide band of sonic coupling compound lengthwise on the face of the transducer and stick it to the outside pipe wall to get good measurement results. However, the following inspections still need to be carried out in order to ensure the high reliability of the measurement and long-term operation of the instrument.



SIGNAL STRENGTH

Signal strength (displayed in Window M04) indicates a detected strength of the signal both from upstream and downstream directions. The relevant signal strength is indicated by numbers from 00.0 ~ 99.9. 00.0 represents no signal detected while 99.9 represent maximum signal strength. Normally, the stronger the signal strength detected, the longer the operation of the instrument reliably, as well as the more stable the measurement value obtained.

Adjust the transducer to the best position and check to ensure that enough sonic coupling compounds is applied adequately during installation in order to obtain the maximum signal strength.

System normally requires signal strength over 75.0, which is detected from both upstream and downstream directions. If the signal strength detected is too low, the transducer installation position and the transducer mounting spacing should be re-adjusted and the pipe should be re-inspected. If necessary, change the mounting method to be Z method.

SIGNAL QUALITY (Q VALUE)

Q value is short for Signal Quality (displayed in Window M04). It indicates the level of the signal detected. Q value is indicated by numbers from 00 ~ 99. 00 represents the minimum signal detected while 99 represent the maximum. Normally, the transducer position should be adjusted repeatedly and coupling compound application should be checked frequently until the signal quality detected is as strong as possible.

TOTAL TIME AND DELTA TIME

"Total Time and Delta Time", which displays in Window M04, indicates the condition of the installation. The measurement calculations in the Flow meter are based upon these two parameters. Therefore, when "Delta Time" fluctuates widely, the flow and velocities fluctuate accordingly, this means that the signal quality detected is too poor. It may be the resulted of poor pipe-installation conditions, inadequate transducer installation or incorrect parameter input.

Generally, "Delta Time" fluctuation should be less than $\pm 20\%$. Only when the pipe diameter is too small or velocity is too low can the fluctuation be wider.

TRANSIT TIME RATIO

Transit Time Ratio indicates if the transducer mounting spacing is accurate. The normal transit time ratio should be $100 \pm 3\%$ if the installation is proper. Check it in Window M04.



CAUTION!

If the transit time ratio is over $100 \pm 3\%$, it is necessary to check:

- (1) If the parameters (pipe outside diameter, wall thickness, pipe material, liner, etc.) have been entered correctly,
- (2) If the transducer mounting spacing is accordance with the display in Window M14,
- (3) If the transducer is mounted at the pipe's centerline on the same diameter,
- (4) If the scale is too thick or the pipe mounting is distorted in shape, etc.



3.3 WARNINGS

- ❖ Pipe parameters entered must be accurate; otherwise the Flow meter will not work properly.
- ❖ During the installation, apply enough coupling compounds in order to stick the transducers onto the pipe wall. While checking the signal strength and Q value, move the transducers slowly around the mounting site until the strongest signal and maximum Q value can be obtained. Make sure that the larger the pipe diameter, the more the transducers should be moved.
- ❖ Check to be sure the mounting spacing is accordance with the display in Window M14 and the transducer is mounted at the pipe's centerline on the same diameter.
- ❖ Pay special attention to those pipes that formed by steel rolls (pipe with seams), since such pipe is always irregular. If the signal strength is always displayed as 0.00, that means there is no signal detected. Thus, it is necessary to check that the parameters (including all the pipe parameters) have been entered accurately. Check to be sure the transducer mounting method has been selected properly, the pipe is not worn-out, and the liner is not too thick. Make sure there is indeed fluid in the pipe or the transducer is not too close to a valve or elbow, and there are not too many air bubbles in the fluid, etc. With the exception of these reasons, if there is still no signal detected, the measurement site has to be changed.
- ❖ Make sure that the Flow /BTU meter is able to run properly with high reliability. The stronger the signal strength displayed, the higher the Q value reached. The longer the Flow /BTU meter runs accurately, the higher the reliability of the flow rates displayed. If there is interference from ambient electromagnetic waves or the signal detected is too poor, the flow value displayed is not reliable; consequently, the capability for reliable operation is reduced.
- ❖ After the installation is complete, power on the instrument and check the result accordingly.



4 ELECTRICAL CONNECTIONS

4.1 SAFETY INSTRUCTIONS



DANGER!

Only when power is switched off, can we do all the work about electrical connections. Please pay all attention to the power supply on the name plate!



DANGER!

Observe the national regulations for electrical installations!



DANGER!

For devices used in hazardous areas, additional safety notes apply; please refer to the Ex documentation.



WARNING!

Observe without fail the local occupational health and safety regulations. Any work done on the electrical components of the measuring device may only be carried out by properly trained specialists.



INFORMATION!

Look at the device nameplate to ensure that the device is delivered according to your order. Check for the correct supply voltage printed on the nameplate.



INFORMATION!

Connect the cable on connector with similar numeral marking



INFORMATION!

Ensure the meter operates correctly by supplying it with a dedicated 24 VDC input power source

4.2 WIRE CONNECTING

4.2.1 POWER SUPPLY OPTION



INFORMATION!

Customers should pay special attention to specify the desired power supply when wiring. Factory standard power supply is 24VDC/1A max.



INFORMATION!

To ensure the transmitter can work normally, please pay attention to the followings when wiring: Ensure that power connections are made in accordance with the specifications shown on the transmitter.



4.2.2 TRANSMITTER WIRING

Once the electronics enclosure has been installed, the flow meter wiring can be connected. Open the case, you will find the Power board wiring ports, from left to right, are as follows; Connect to DC power (24V), Relay Output, OCT Output, Transducer wiring, 4-20mA Output, RS232 Output, RS485 Output, Analog Input.

For double-shielded transducer cable: "-" on the Blue wire, "+" on the Brown wire and "shield" on the Black shield wire.

Refer to the below diagram for specific connection:

Sign	Description
DC+	DC Power DC 24V +
DC-	DC Power DC 24V -
⊕	Grounding
RL OUT+	Relay Output
RL OUT-	
OCT OUT+	OCT Output
OCT OUT-	
GND	Upstream sensor Grounding Black
UP+	Upstream sensor + Brown
UP-	Upstream sensor - Blue
GND	Downstream sensor Grounding Black
DN+	Downstream sensor + Brown
DN-	Downstream sensor - Blue
I OUT+	4~20mA Output
I OUT-	
AI1	Analog Signal Input (Only Energy Meter)
AI2	
GND	
TX	RS232 Output
HX	
GND	
A	RS485 Output
B	
IN1+	Temperature sensor water inline +
IN1-	Temperature sensor water inline -
GND	Temperature sensor water inline grounding
IN2+	Temperature sensor water outline +
IN2-	Temperature sensor water outline -
GND	Temperature sensor water outline grounding

MUF 1200 FLOW METER WIRING DIAGRAM

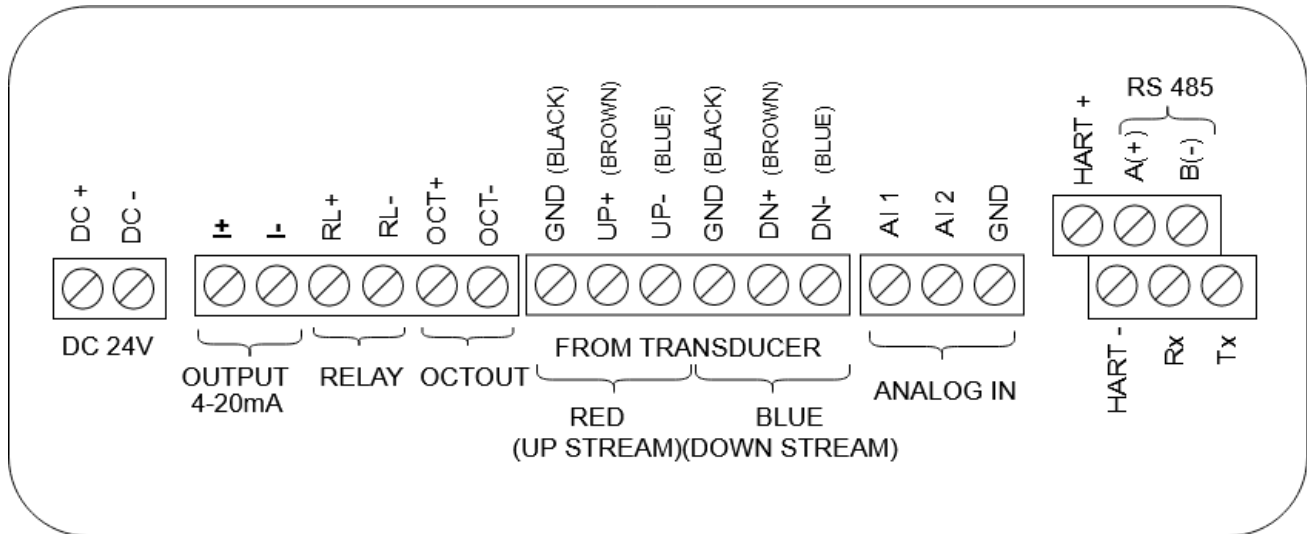

MUF 1200 MODBUS CONFIGURATION DETAILS OF FLOW METER TO BMS

Function Code	Details	Register Address	Modbus Register	Register Type
03: Holding Register	Flow Rate	05	40005	Floating Point (32 bit)
	Flow Total	09	40009	Floating Point (32 bit)

Parity : None
Word Length : 8
Stop Bit 1

Note: If your BMS register address starts from '0', please decrement '1' value from every register. Example: Flow rate register is 40006 then it should be configured as 40005.

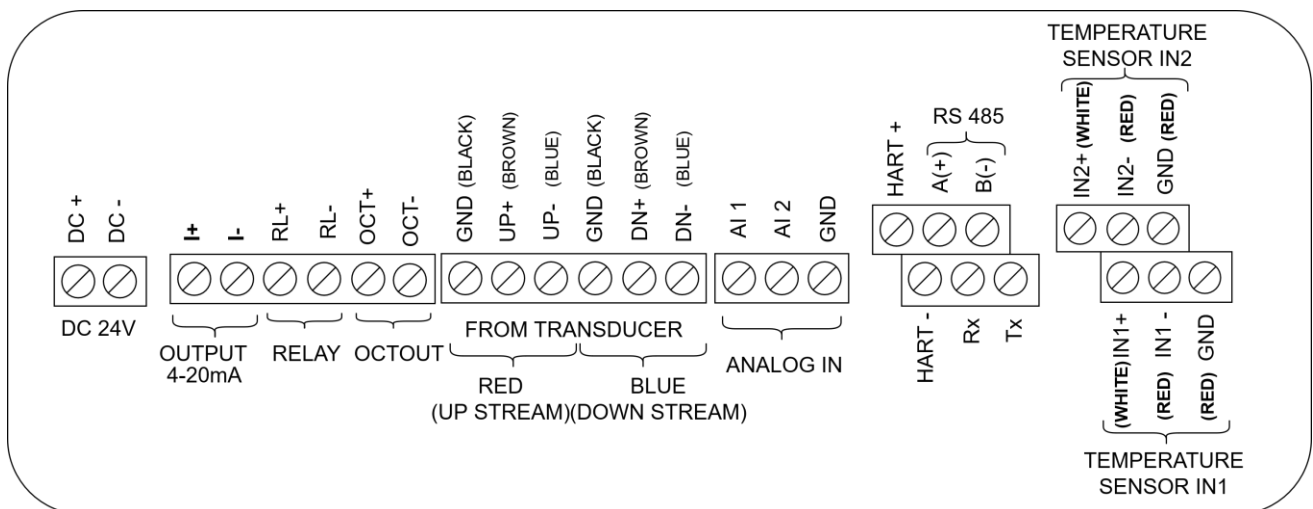

MUF(B) -1200 BTU METER WIRING DIAGRAM



Function Code	Details	Register Address	Modbus Register	Register Type
03: Holding Register	Supply Temperature	74	40074	Floating Point (32 bit)
	Return Temperature	76	40076	Floating Point (32 bit)
	Energy Rate	18	40018	Floating Point (32 bit)
	Energy Total	23	40023	Floating Point (32 bit)
	Flow Rate	05	40005	Floating Point (32 bit)
	Flow Total	09	40009	Floating Point (32 bit)

MUF(B)-1200 BTU MODBUS CONFIGURATION DETAILS OF FLOW METER TO BMS

Parity	: None
Word Length	: 8
Stop Bit	: 1

Note: If your BMS register address starts from '0', please decrement '1' value from every register.
Example: Supply temperature register is 40075 then it should be configured as 40074.



WARNING!

Wire when it is power-off. Reliable grounding must be taken for the instrument before installation and use.



WARNING!

Use either AC or DC power supply. Do not connect them both at the same time.

4.3. POWERING ON

As soon as the flow meter is switched on, the system will run automatically according to the last input parameters. If the installation is accomplished when system is switched on, gain adjustment can be monitored in Window M04. After code "**R" are displayed on the upper right corner of the screen, the system will activate the normal measurement condition automatically. It is indicated by code "**R" on the upper left corner of the screen.

If it is the first time to use or install on a new site, the customer need to input the new installation site parameters. Any parameters which are set by user will be saved permanently until they are changed by the user.

When the user modifies the parameters and removes the transducers, the meter will recalculate



automatically, and operate normally with the parameters.

The flow meter can always complete all tasks at the same time. The tasks (Including measurement, output, etc) will be carried out as usual, no matter in which display window.

4.4. KEYPAD FUNCTIONS

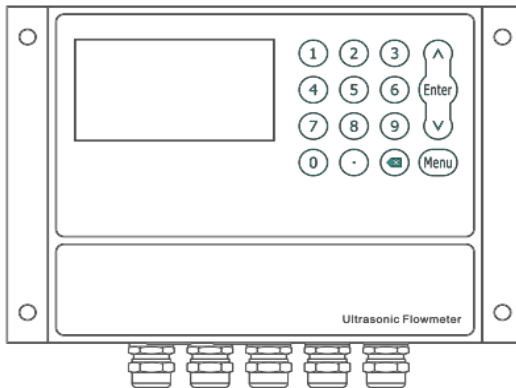

Numbers —0~9|| and —.|| Input Numbers or Menu Code

—← ||Backspace or delete characters to the left or back to the previous menu.

—↑↓||Return to the last menu or open the next menu. Acts as "+" and "-" are used to enter numbers.

— Menu||Select a menu. Press this key first, then input two menu numbers to display the selected menu.

4.5 KEYPAD OPERATION

The flow meter adopts the window software design to consolidate or subdivide all of the parameters entered, the instrument setup and measurement result displays into independent windows. The operator can input parameters, modify settings or display measurement results by "visiting" a specific menu window. Each window serial number, or so-called window ID code, has a defined meaning. For example, Window M10 indicates the parameter input for pipe outside diameter, while Window M14 indicates the mounting spacing between the transducers, etc. (Refer – Windows Display Explanations).

The keypad shortcut to visit a specific window is to press the — Menu|| key at any time, then input the 2-digit window

ID code. For example, to input or check the pipe outside diameter, just press the — Menu||

—1|| —0|| keys

for window ID code 10. Use —↑||and —↓|| to switch.

Another method to visit a particular window is to press —↑||and —↓|| to scroll the screen.

You can check the corresponding parameters by visiting the Data Type Windows. If you want to modify the parameters, press — Enter || first, input the digits then press — Enter || again to confirm



WARNING!

Generally, press key first if operator wants to enter "modify" status. If the "modify" is still not possible even after pressing the key, it means that system is locked by a password. To "Unlock" it, select "Unlock" in Window M54 and enter the original password.

5 OPERATION

5.1. BASIC SETTINGS

For example, let us you have a pipe of 200mm outer diameter, 4mm pipe thickness, measuring medium is water, Pipe Material is PVC with no Liner, These parameters should be operated as follows:

STEP1. PIPE SIZE SETTINGS

Find M10, enter the pipe size, the outer diameter of the pipe and the pipe thickness.

press the  to confirm.

M10	Pipe settings	*R
Size	M.	
OD	200.0	mm
thk	4.0	mm

STEP2. PIPE MATERIAL

Use  to switch to select the material of the pipe.

And press the  to confirm.

M10	Pipe settings	*R
Size	M.	
	M.	0.PVC
Other	3200	m/s

STEP 3. WATER TEMPERATURE

Find M12, select the temperature of the water, temperature should be 0-60 deg. C.

Press the — Enterll to confirm.

Note: Room temperature is 25 deg.C

M12	Medium	*R
WTMP	20	(° C)



STEP4. TRANSDUCER TYPE

Find M13, select the transducer type, here we select the 1. Clamp-On D, our standard clamp on type transducer.

Press the  to confirm.

M13	Transducer	*R
Type	Method	
Option	0.Clamp-On D	

STEP 5. TRANSDUCER MOUNTING METHODS

Use  to switch to select transducers mounting method, here we select 0. V type, directly method. Press the  confirm.

M13	Transducer	*R
Type	Method	Mode
Option	0.V	

STEP 6. INSTALLATION SPACING

Find M14, accurately install the transducer according to the displayed transducer mounting spacing and the selected mounting method.

M14	INSTL Spacing	*R
Value	154.2	mm

STEP 7. DISPLAY MEASUREMENT RESULTS

Menu 01 will display flow rate. (Subject to the real measurement.)

M01	Flow Rate	*R
Flow	Vel.	
100.2		m ³ /h

5.2 SYSTEM NORMAL IDENTIFICATION

If the letter "*R" displays on the screen, it indicates system normal.

If the letter "D" is displayed, it indicates that system is adjusting the signal gain prior to the measurement. Also, it means system normal. Only when the adjustment takes too long without stopping, can system be identified as abnormal.

Letter "E" indicates no signal is being detected. Check the transducer wiring connections are correct, the transducers are installed firmly, etc.

For further information, please refer to "Error Diagnosis".

5.3 LOW FLOW CUTOFF VALUE

The data in M21 is Low Flow Cutoff Value. If the flow rate falls below the low flow cutoff value, the flow indication is driven to zero. This function can prevent the flow meter from displaying flow as "0" after a pump was shut down, but there is still liquid movement in the pipe, which will result in cumulative error. Generally, 0.03m/s is recommended to enter as the low flow cutoff point.

The low flow cutoff value has no relation to the measurement results once the velocity increases over the low flow cutoff value.



5.4 ZERO SETTINGS

Once zero flow occurs, a zero point may indicate on each measuring instrument, but the displayed measuring value is not equal to "0", this value indicates "Zero". To any measuring instrument, the smaller the "Zero" is, the better the quality is. Conversely, if the Zero is too big, that indicates the quality of the instrument is poor.

If the zero set point is not at true zero flow, a measurement difference may occur. The smaller the physical measurement capacity is, the larger the measurement difference from the zero point will exist. Only when zero point reduced to a definite degree, as compared with the physical measurement capacity, can the measuring difference from zero point be ignored.

For an ultrasonic Flow meter, the measurement error from zero point cannot be ignored under low flow conditions. It is necessary to perform a static zero set calibration to improve low flow measurement accuracy.

Cutoff Zero

In Window M22- Cutoff- 1.Yes, window will show the —success ll and back to M01 when you cut off the zero point successfully.

Performing Set Zero

In Window M22- Reset

5.5 SCALE FACTOR

Scale factor refers to the ratio between "actual value" and "reading value". For example, when the measurement is 2.00, and it is indicated as 1.98 on the instrument, the scale factor reading is 2/1.98. This means that the best scale factor constant is 1. However, it is difficult to keep the scale factor as "1" on the instrument especially in batch productions. The difference is called "consistency".

During operation, there still exists possible difference in pipe parameters, etc. The "scale factor" may be necessary when used on different pipes. Thus, scale factor calibration is specially designed for calibrating the differences that result from application on different pipes. The scale factor entered must be one that results from actual flow calibration. The scale factor can be input in Window M26.

5.6 SYSTEM LOCK

System lock is intended to prevent operation error due to tampering by unauthorized personnel.

M54 is for system lock, unlock it by using the selected password only. If "lockll is displayed on the screen, then enter the correct password.

Keep the password in mind or recorded in a safe place, otherwise the instrument cannot be used.

5.7 4 ~ 20mA CURRENT LOOP OUTPUT

With a current loop output exceeding an accuracy of 0.1%, the flow meter is programmable and configurable with outputs such as 4 ~ 20mA or 0 ~ 20mA selected in Menu 32. For details, please refer to Menu 32 in "Window Display Explanations".

In Window M32- Range- LowL, enter a 4mA flow value. Enter the 20mA flow value in Window M32- Range-UpperL. For example, if the flow range in a specific pipe is 0 ~ 1000m³/h, enter 0 in Window M32 and 1000 in Window M32. If the flow ranges from -1000 ~ 0 ~ 2000m³/h, configure the 20 ~ 4 ~ 20mA output by selecting in Window M32 when flow direction is not an issue. Enter 1000 in Window M32 LowL and 2000 in Window M32 UpperL. When flow direction is an issue, module 0 ~ 4 ~ 20mA is available. When the flow direction displays as negative, the current output is in

range of 0 ~ 4mA, whereas the 4 ~ 20mA is for the positive direction. The output module options are displayed in Window M32.

Calibrating and testing the current loop is performed in Window M32-Check. Complete the steps as follows:



Use the buttons to switch. "check 4mA", "check 8mA", "check 16mA", "check 20mA" readings, connect an ammeter to test the current loop output and calculate the difference. Calibrate the 4-20mA is in M62.

5.8 FREQUENCY OUTPUT

The flow meter is provided with a frequency output transmitter function. The high or low frequency output displayed indicates the high or low flow rate reading. The user can reset the frequency output as well as flow rate as the user's actual requirements.

For example: if a pipe flow range is 0 ~ 5000m³/h, the relative frequency output required is 100 ~ 1000Hz, and the configuration is as follows:

In Window M33-Range-LowerL (lower limit frequency output flow value), input 0;

In Window M33-Range -UpperL (upper limit frequency output flow value), input 5000; In Window M33-Mode-Frange(frequency range), input 100、1000;

In Window M33-Mode-Option, select —a.Flow Ratell; Typical OCT Output wiring diagram as below

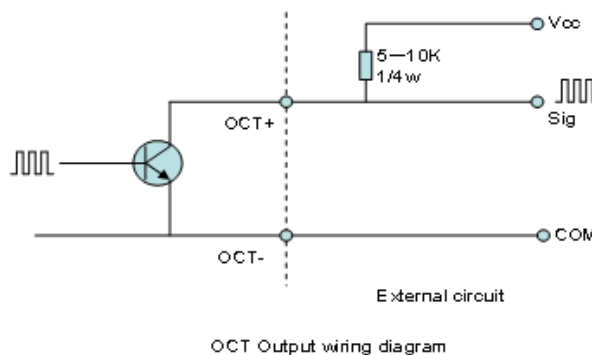

5.9 TOTALIZER PULSE OUTPUT

Each time the flow meter reaches a unit flow, it may generate a totalizer pulse output to a remote counter.

The totalizer pulse output can be transmitted through OCT or a relay. Therefore, it is necessary to configure OCT and the relay accordingly. (Please refer to Window M33 and M34). For example, if it is necessary to transmit the positive totalizer pulse through a relay, and each pulse represents a flow of 10m³, the configuration is as follows:

In Window M41-Unit, select the totalizer flow unit "m³"; In Window M41-MULT, select the scale factor "e. x10"; In Window M34-Option, select "g. POS Total";



WARNING!

Make sure to select an appropriate totalizer pulse. If the totalizer pulse is too big, the output cycle will be too long; if the totalizer is too small, the relay will operate too faster, you may shorten the life of the relay, as well as skip some pulses. The totalizer is recommended to transmit within the range of 1 ~ 3 pulse per second.



5.10 ALARM PROGRAMMING

The on-off output alarm is generated through OCT or transmission to an external circuit by opening or closing a relay. The on-off output signal is activated under the following conditions:

- Signal not detected;
- Poor signal detected;
- The flow meter is not ready for normal measurement;
- The flow is in the reverse direction (back flow).
- The analog outputs exceed span by 120%.
- The frequency output exceeds span by 120%.

The flow rate exceeds the ranges configured (Configure the flow ranges using the software alarm system. There are two software alarms: Alarm#1 and Alarm #2.

Example 1: When flow rate exceeds 300 ~ 1000 m³/h, in order to program the relay output alarm, Complete the steps as follows:

- In Menu 35, Alarm1 LowL 300;
- In Menu 35, Alarm1 Upper 1000;
- In Menu 34, Relay Setting-Option-d.Alarm1

5.11 4-20mA ANALOG OUTPUT CALIBRATION





WARNING!

Each flow meter has been calibrated strictly before leaving factory. It is unnecessary to carry out this step except when the current value (detected while calibrating the current loop) displayed in Window M32 is not identical with the actual output current value.

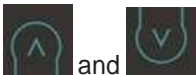

The hardware detect window must be activated prior to calibration the Analog Output. The procedure is as follows:

Menu 62 is for 4-20mA calibration, if you need enter the pass word to enter. With no effect to next power on, this window will close automatically as soon as the power is turned off.



Use  and  to switch calibrate the current loop 4mA output. Use an ammeter to measure the output current of current loop and adjust the displayed numbers at the same time. Watch the ammeter until it reads 4.00. Stop at this point, the 4mA has been calibrated.



Use  and  to switch calibrate the current loop 20mA output. The method is the same as 4mA calibration. The results are automatically saved in EEPROM and won't lose when power off.

5.12ESN

We provide the flow meter with a unique electronic serial number to identify each flow meter for the convenience of the manufacturer and customers. The ESN, instrument types and versions are able to view in Window M61.

ATTENTION



WARNING!

Other Operating Refer to "6.2 Window Display Explanati



6 Windows Display Explanations

6.1 WINDOWS DISPLAY CODES

	Easy Introduction	A class of the menu
M0X	Display Value and Condition *R- System Normal *E - Signal Not Detected *D- Adjusting Gain	M00 Flow Totalizer
		M01 Flow Rate
		M02 Energy Totalizer
		M03 Energy Rate
		M04 Status
M1X	Installation Setting	M10 Pipe Settings
		M11 Lining Settings
		M12 Liquid Settings
		M13 Transducer Settings
		M14 Installation Space
M2X	Calibration Setting	M20 Damping
		M21 Low Flow Cut off Value
		M22 Zero Point Settings
		M23 Energy Totalizer Settings
		M24 Temperature Sensitivity Settings
		M25 Automatic Flow Correction
		M26 K Factor Setting
		M27 Linear Calibration settings
M3X	Input and Output Settings	M30 Serial Port Parameter
		M31 AI Settings
		M32 4-20mA Settings
		M33 OCT Settings
		M34 Relay Settings



M3X	Input and Output Settings	M35 Alarm Value Settings
		M36 Flow Batch Settings
		M37 Micro SD Settings
M4X	Flow Unit Opinions	M40 Metric system Units
		M41 Flow Rate Units
		M42 BTU Units
		M43 Temperature Units
M5X	System Settings	M50 Serial Number
		M51 Time and Date
		M52 Beeper Setup
		M53 Initial Interface Settings
		M54 System Lock Settings
		M55 Restore Factory Settings
M6X	Others	M60 Date Totalizer
		M61 Working Timer
		M62 4-20mA Calibration
		M63 RTD Calibration
		M64 AI Calibration

NOTE : The other menu features are retained by manufacturer



6.2 DISPLAY EXPLANATIONS

M00

FLOW TOTAL

Display Net

Totalizer. Display

Positive totalizer.

Display Negative

totalizer.

Use  and  to switch.

M00	Flow Total		*R
NET	POS	NEG	
123.4			E+0 m ³

M00	Flow Total		*R
NET	POS	NEG	
123.4			E+0 m ³

M01

FLOW RATE

Display the Flow Rate and Flow Total Display the FlowRate.

* Flow Total and the Flow Velocity switch every 6 seconds, Use the ENTER to stop the switch.

M01	Flow Rate		*R
123.4	E+0	m ³	
100.2		m ³ /h	

M01	Flow Rate		*R
2.1		m/s	
100.2		m ³ /h	



M02

HEAT RATE

Display the Heat Total.

Display the Heat Rate and the Inlet Water Temp and Outlet Water Temp.

NOTE:

Instrument needs energy capacity.

x 0.001 (E-3)	x 0.01(E-2)
x 0.1(E-1)	x 1(E+0)
x 10(E+1)	x 100(E+2)
x 1000(E+3)	x 10000(E+4)

Heat Rate, Inlet water Temperature and Outlet water Temperature switch every 6 seconds, Use the ENTER to stop the switch.

M03

COOL RATE

Display the Cool Total.

Display the Cool Rate and the Inlet Water Temp and Outlet Water Temp. NOTE:

Instrument needs energy capacity

x 0.001 (E-3)	x 0.01(E-2)
x 0.1(E-1)	x 1(E+0)
x 10(E+1)	x 100(E+2)
x 1000(E+3)	x 10000(E+4)

* Cool Rate, Inlet water Temperature and Outlet water Temperature switch every 6 seconds, Use the ENTER to stop the switch.

M02	Heat	*R
100.2		GJ/h
234.5		E+0 GJ

M02	Heat	*R
ST: 7.0	RT: 12.0	(° C)
234.5		E+0 GJ

M03	Cool	*R
100.2		GJ/h
201.6		E+0 GJ

M03	Cool	*R
ST: 7.0	RT: 12.0	(° C)
201.6		E+0 GJ



**M04
Status**

Display the Signal strength, the Upstream signal strength and Downstream signal strength.

Signal quality Q is indicated by 00 ~ 99. Therefore, 00 indicates the poorest signal while 99 indicates the best signal. Normally, signal quality Q value should be better than 60

M04	Status	*R
Signal	Sound	Time
Up	Dn	Q
80.0	80.1	85

Display the measured fluid sound velocity. Normally this value should be approximately equal to the entered value in Window M12. If the difference is too large, it probably results from an incorrect value entered in Window M12 or improper installation of the transducers.

Display the ratio between the actual measured transmit

time and the calculated transmit time according to customer's requirement. Normally the ratio should be 100±3%. If the difference is too large, the user should check that the parameters are entered correctly, especially the sound velocity of the fluid and the installation of the transducers.

This data is of no use before the system is ready.

M04	Status	*R
Signal	Sound	Time
Vel.	1482	E+0
Ratio	100%	m ³

Display the measured ultrasonic average time (unit: us) and delta time of the upstream and downstream (unit: ns) time. The velocity calculation in the flow meter is based on the two readings. The delta time is the best indication that the instrument is running steadily. Normally the fluctuation in the ratio of the delta time should be lower than 20%. If it is not, it is necessary to check if the transducers are installed properly or if the parameters have been entered correctly.

M04	Status	*R
Signal	Sound	Time
Total	185.0	us
Delta	30.5	ns



M10

Pipe settings

Enter the pipe outer diameter; the pipe outer diameter must range from 10mm to 6000mm.

Note: Enter Either pipe outer diameter or pipe outer perimeter

Enter the pipe wall thickness. Pipe wall thickness is necessary.

M10	Pipe settings	*R
Size	M.	
OD	108.0	mm
thk	4.0	mm

Enter pipe material. The following options are available:

0. PVC

1. CS Carbon Steel

2. SSP Stainless Steel Pipe

3. CIP Cast Iron Pipe

4. DIP Ductile Cast Iron Pipe

5. Copper

6. Alu. Aluminum pipe

7. ACP Asbestos Cement Pipe

8. FPG Fiberglass Pipe

9. Other

Refer to item 9 "Other"; it is possible to enter other materials, which are not included in previous eight items. Once item 9 is selected, the relevant pipe sound velocity must be entered.

M10	Pipe settings	*R
Size	M.	
	M.	0.PVC
Other	3200	m/s

M11

LINING

Enter liner thickness.

M11	Lining	*R
Size	M.	
thk	3.0	mm



Refer to item 9 "Other"; it is possible to enter other materials, which are not included in previous eight items. Once item 9 is selected, the relevant pipe sound velocity must be entered.

Use and to switch.

Select the Liner Material.

The following options are available:

0. No liner
1. Tar Epoxy
2. Rubber
3. Mortar
4. PP Polypropylene
5. Polystryol
6. PS Polystyrene
7. Polyester
8. PE Polyethylene
9. Ebonite
10. Teflon
11. Other

Item 11 "Other" is available to enter other materials that are not included in previous ten items. Once the "Other" is selected, the relevant liner sound velocity must be entered.

M11		Lining	*R
Size		M.	
	M.	0.No Liner	
Other		2400	m/s

M12
MEDIUM

Select measure medium.



The following options are available:

0. Water
1. Water 125 degC
2. Seawater
3. Kerosene
4. Gasoline
5. Fuel Oil
6. Crude Oil
7. Diesel Oil
8. Castor Oil
9. Peanut Oil
10. Alcohol
11. Propane (-45°C)
12. Butane (0°C)
13. Gas #93
14. Other

Item 15 "Other" is available to enter other materials that are not included in previous ten items. Once the "Other" is selected, the relevant liner sound velocity must be entered.

M12	Medium	*R
WTMP	20	(° C)

M13

TRANSDUCER

Select transducer type

The following options are available:

0. Clamp-On
1. Clamp-On S
2. Clamp-On X
3. Plus-In
4. Plus-In X

Select transducer Mounting

Methods Three mounting

methods are available:

M13	Transducer	*R
Type	Method	
Option	0.Clamp-On	

M13	Transducer	*R
Type	Method	
Option	0.V	



- 0. V Reflect method
- 1. Z Direct method
- 2. N

NOTE: Model is Engineer menu.

M14
INSTALLATION SPACE

This value is calculated by the flow meter
The operator must mount the transducer according to the transducer spacing displayed (ensure that the transducer spacing is measured precisely during installation). The system will display the data automatically after the pipe parameter had been entered.

M14	INSTL Spacing	*R
Value	20.0	mm

M20
DAMPING

The damping factor ranges from 1 ~ 999 seconds. 1 indicates no damping; 999 indicates the maximum damping.
The damping function will stabilize the flow
Usually a damping factor of 3 to 10 is recommended in applications.

M20	Damping	*R
Value	6	

M21
LOW VEL. CUT OFF

Low Flow Cut off is used to make the system display as "0" value at lower and smaller flows to avoid any invalid totalizing. For example, if the cutoff value is set as 0.03, system will take all the measured flow velocity values from - 0.03 to + 0.03 as "0". Generally, 0.03 is recommended in most applications.

M21	Low Vel. Cutoff	*R
Value	0.03	m/s



M22

ZERO SETTINGS

When fluid is in the static state, the displayed value is called "Zero Point". When "Zero Point" is not at zero in the flow meter, the difference is going to be added into the actual flow values and measurement differences will occur in the flow meter.

Set zero must be carried out after the transducers are installed and the flow inside the pipe is in the absolute static state (no liquid movement in the pipe). Thus, the "Zero Point" resulting from different pipe mounting locations and parameters can be eliminated. The measuring accuracy at low flow is enhanced by doing this and flow offset is eliminated. Select "YES"; reset "Zero Point" which was set by the user.

M22	Zero Settings	*R
Cutoff	Reset	Offset
Option	0.No	

M22	Zero Settings	*R
Cutoff	Reset	Offset
Option	0.No	

This method is not commonly used. It is only suitable for experienced operators to set zero under conditions when it is not preferable to use other methods. Enter the value manually to add to the measured value to obtain the actual value. For example:

Actual measured value = 240

m³/H Value Deviation = 10
m³/H

Flow meter Display = 250

m³/H Normally, set the value as "0".

Use  and  to switch.

M22	Zero Settings	*R
Cutoff	Reset	Offset
Value	0.0	m ³ /h

M23

TOTALIZER

Select the totalizer type

- 0. POS Positive Totalizer
- 1. NEG Negative Totalizer

M23	Totalizer	*R
Switch	Reset	
Flow	0.POS	0.ON
Energy	0.Heat	0.ON



2. NET

Select energy type

0. Heat

1. Cool

Select "ON"/"OFF" to switch the totalizer.

Select the flow totalizer value you want
Reset

0. POS Positive Totalizer

1. NEG

2. NET Negative Totalizer

3. All

Select the energy totalizer value you want Reset

0. Heat

1. Cool

2. All

M24
TEMPERATURE

Select Heat Input Options:

0. RTD

1. AI

Use  and  to switch.

Temperature Sensitivity Setting

When the delta temperature is less than the sensitivity set, energy will not be accumulated. Set the adjustable temperature range of 0°C ~ 20°C. The factory default setting is 0.2 °C.

Select Specific Heat Options:

0. CJ128 SHC

M23	Totalizer	*R
Switch	Reset	
Flow	0.POS	
Energy	0.Heat	

M24	Temperature	*R
Source	SSTV	SHC
Option	0.RTD	

M24	Temperature	*R
Source	SSTV	SHC
Value	0.20	° C

M24	Temperature	*R
Source	SSTV	SHC
Option	0.CJ128	m ³ /h
Other	4.2	KJ/m ³ °C



1. Other

Use  and  to switch.

M25

POWER DOWN CORRECTION SWITCH

With the function of power down automation correction switch, the flow lost in an offline session can be estimated and automatically adjusted. The estimate is based on the average value, which is obtained from flow rate before going offline and flow measured after going online the next time, multiplied times the time period that the meter was offline. Select "ON" to use this function, select "OFF" to cancel this function

M25	PowerDown COMP	*R
Option	0.ON	

M26

K FACTOR

The K factor is used to modify the measurement results. The user can enter a numerical value (other than "1") according to the actual calibration results.

M26	K Factor	*R
Value	1.000	



M27

CORRECTION

Sectional Correction

ON: Open the Sectional Correction Function; OFF: Close the Sectional Correction Function

Delay correction

Engineer menu, suggest customer use the factory setting.

TPC

Transducers power control

Engineer menu, suggest customer use the factory setting.

- 0. Auto
- 1. Low
- 2. High

M27	Correction	*R
KArray	Delay	TPC
Option	0.ON	
Value	*****	

M27	Correction	*R
KArray	Delay	TPC
Value	0.0	us

M27	Correction	*R
KArray	Delay	TPC
Option	0.Auto	



M28

SQA

Statistic Analysis

M28	SQA	*R
Set	Reset	
Option	0.ON/1.OFF	
Value	4.500	

M28	SQA	*R
Set	Reset	
Option	0.Auto	
Value	4.500	

M30

RS232/RS485

Serial Port Setting

- . 2400 None
- . 4800 None
- . 9600 None
- . 19200 None
- . 38400 None
- . 56000 None

You can setting the order as following :

- a. 1-0: 3-2 b.
- b. 0-1:2-3
- c. c. 3-2:1-0
- d. d. 2-3:0-1

M30	RS232/RS485	*R
Option	0.2400 None	
ID	55	

M30	RS232/RS485	*R
Set	Order	
Option	a.1-10: 3-2	

M30	RS232/RS485	*R
Set	Order	
Option	a.1-10: 3-2	



M31
AI SETTING

Display analog input AI1 analog value.

M31	AI Settings	*R
AI1	AI2	
LowerL		1.0
UpperL		1000.0

Display analog input AI2 analog value.

M31	AI Settings	*R
AI1	AI2	
LowerL		1.0
UpperL		1000.0

M32
CL SETTING

Current Loop Mode

Options Select the CL

Range value

M32	CL Settings	*R
Mode	Range	Check
Option		a.4-20mA

Set the CL output value according to the flow value at 4mA or 0mA.

Set the CL output value according to the flow value

M32	CL Settings	*R
Mode	Range	Check
LowerL	0.0	m ³ /h
UpperL	1000.0	m ³ /h

4-20mA check opinions



- a. Check 4mA
- b. Check 8mA
- c. Check 12mA
- d. Check 20mA

M33	OCT Settings	*R
Mode	Range	Check
Option	a.Check 500	

**M33
OCT SETTING**

The following signal options are available:

- a. Flow Rate
- b. POS Total
- c. NEG Total
- d. NET Total
- e. Energy Rate
- f. Heat Total
- g. Cool Total
- h. Rationing
- i. Uart CTRL

M33	OCT Settings	*R
Mode	Range	Check
Option	a.Flow Rate	
Frang	0-5000 Hz	

Select the OCT Range value.

M33	OCT Settings	*R
Mode	Range	Check
LowerL	0.0	m ³ /h
UpperL	1000.0	m ³ /h

OCT check opinions

- a. Check 500
- b. Check 1000
- c. Check 3000
- d. Check 5000

M33	OCT Settings	*R
Mode	Range	Check
Option	a.Check 500	



M34
RELAY SETTING

The following signal options are available:

- a. No Signal
- b. *E
- c. Reverse
- d. Alarm1
- e. Alarm2
- f. Ration
- g. POS Total
- h. NEG Total
- i. NET Total
- j. Not Using

M34	Relay Settings	*R
Option	a.No Signal	

M35
ALARM SETTING

Enter the Lower \ alarm value, any of the measured flow, which is lower than the low value, will activate the alarm in the OCT hardware or relay output signal.

M35	Alarm Settings	*R
Alarm1	Alarm2	
LowerL	0.0	m ³ /h
UpperL	1000.0	m ³ /h

Enter the Upper alarm value, any of the measured flow, which is higher than the high value, will activate the alarm in the OCT hardware or relay output signal.

M35	Alarm Settings	*R
Alarm1	Alarm2	
LowerL	0.0	m ³ /h
UpperL	1000.0	m ³ /h



M36
RATION

Following is the Ration opinions:

- a. Key CTRL
- b. AI1 CTRL
- c. AI2 CTRL
- d. Uart CTRL

M36	Ration	*R
Option	a.Key CTRL	
Value	1000.0	m ³ /h

M40
TOGGLE UNIT

Select the measurement unit as follows:

- a. Metric
- b. British

M40	Toggle Unit	*R
Option	a.Metric	

M41
FLOW UNIT

The following flow rate units are available:

- 0. Cubic Meters (m³)
- 1. Liters (l)
- 2. USA Gallons (GAL)
- 3. Imperial Gallons (Imp gal)
- 4. Million Gallons (mg)
- 5. Cubic Feet (cf)
- 6. USA Barrels (US bbl)
- 7. Imperial Barrels (Imp bbl)
- 8. Oil Barrels (Oil bbl)

The following time units are available:

- /Day /Hour
- /Min /Sec

M41	Flow Unit	*R
Unit	MULT.	
Rate	m ³ /h	
Total	m ³	



Factory default is Cubic Meters/hour.

a. x 0.001 (E-3)	b. x 0.01(E-2)
c. x 0.1(E-1)	d. x 1(E+0)
e. x 10(E+1)	f. x 100(E+2)
g. x 1000(E+3)	h. x 10000(E+4)

M41	Flow Unit	*R
Unit	MULT.	
Option		d. *1

M42

ENERGY UNIT

The following Energy units are available:

0. Giga Joule (GJ)	1. Kilocalorie (Kc)
2. MBtu	3. KJ
4. Btu	5. KWh
6. MWh	7. TH

M42	Energy Unit	*R
Unit	MULT.	
Rate		GJ/h
Total		GJ

a. x 0.001 (E-3)	b. x 0.01(E-2)
c. x 0.1(E-1)	d. x 1(E+0)
e. x 10(E+1)	f. x 100(E+2)
g. x 1000(E+3)	h. x 10000(E+4)

M42	Energy Unit	*R
Unit	MULT.	
Option		d. *1

M43

TEMPERATURE UNIT

- a. °C
- b. °F

Use  and  to switch.



SERIAL NUMBER

Display electronic serial number (S/N) of the instrument. This S/N is the only one assigned to each flow meter ready to leave the factory. The factory uses it for files setup and for management by the user.

M50	Serial Number	*R
S/N	FT888888	

M51

TIME AND DATA

Date and time modifications are made in this menu.

M51	Time/Data	*R
Tme	8:10:20	
Date	2017/8/16	

M52

KEY TONE

Use this menu to —ON|| —OFF|| the key tone.

M52	Key Ton	*R
Option	0.ON	

M53

LANGUAGE

Setting the language of the flow meter
0.English

M53	Language	*R
Option	0.English	



M51

**M54
SYSTEM LOCK**

Lock the instrument. Once the system is locked, any modification to the system is prohibited, but the parameter is readable. Entering your designated password correctly can be the only way to "Unlock". The password is composed of 6 numbers. (Please contact the representative or manufacturer as soon as possible when the password is lost.)

M54	System Lock	*R
Option	a.Locked	
Key	*****	

**M55
SYSTEM RESET**

Select 1. Reset to make the instrument back to factory.

M55	System Reset	*R
Option	0. None	

**M60
DATE TOTALIZER**

The following options are available:

- 0. Day
- 1. Month
- 2. Year

In this window, it is possible to review the historical flow data net totalizer for any day for the last 31 days, any month for last 12 months and any year for last 6 years.

M60	Date Totalizer	*R
Day	Mon	Year
Value	08-01	E+0
	100.0	m3

M61	Running Time	*R
Value	5	Day



M61

RUNNING TIME

With this function, it is possible to view the total Working days since the flow meter left the factory.

M62

CL ADJUST

This menu is for the 4-20mA calibration; enter the pass word to adjust.

M62	CL Adjust	*R
4mA	Enter to go	
20mA	Enter to go	

M63

RTD ADJUST

This menu is for the RTD calibration; enter the pass word to adjust.

M63	RTD Adjust	*R
n °C	Enter to go	
180 °C	Enter to go	

M64

RTD ADJUST

This menu is for the AI calibration; enter the pass word to adjust.

M64	AI adjust	*R
AI1	AI2	
4mA	Enter to go	
20mA	Enter to go	



CAUTION!

The entire Menu which related to the temperature, cooling, heating, energy. Only display when it's an energy meter. Flow meter doesn't have the function

M64	AI adjust	*R
AI1	AI2	
4mA	Enter to go	
20mA	Enter to go	



7 Error Diagnoses

The ultrasonic flow meter has advanced self-diagnostics functions and displays any errors in the upper right corner of the LCD via definite codes in a date/time order. Some errors can be detected during normal operation. Undetectable errors caused by unskilled operation, incorrect settings and unsuitable measurement conditions can be displayed accordingly during work. This function helps the user detect the errors and find causes quickly; thus, problems can be solved in a timely manner according to the solutions listed in the following table.

If a problem still exists, please contact the factory or the factory's local representative for assistance.

Table 1. Error Codes and Solutions (during operation)

Codes	The upper right corner of the screen	Causes	Solutions
*R	System Normal	* System normal.	
*E	Signal Not Detected	<ul style="list-style-type: none"> * Signal not detected. * Spacing is not correct between the transducers or not enough coupling compound applied to face of transducers. * Transducers installed improperly. * Scale is too thick. * New pipe liner. 	<ul style="list-style-type: none"> * Attach transducer to the pipe and tighten it securely. Apply a plenty of coupling compound on transducer and pipe wall. * Remove any rust, scale, or loose paint from the pipe surface. Clean it with a file. * Check the initial parameter settings. * Remove the scale or change the scaled pipe section. Normally, it is possible to change a measurement location. The instrument may run properly at a new site with less scale. * Wait until liners solidified and saturated.
*D	Adjusting Gain	* Adjusting gain for normal measurement.	



7.1 FREQUENTLY ASKED QUESTIONS AND ANSWERS

Question: New pipe, high quality material, and all installation requirements met: why still no signal detected?

Answer: Check pipe parameter settings, installation method and wiring connections. Confirm if the coupling compound is applied adequately, the pipe is full of liquid, transducer spacing agrees with the screen readings and the transducers are installed in the right direction.

Question: Old pipe with heavy scale inside, no signal or poor signal detected: how can it be resolved?

Answer: Check if the pipe is full of fluid. Try the Z method for transducer installation (If the pipe is too close to a wall, or it is necessary to install the transducers on a vertical or inclined pipe with flow upwards instead of on a horizontal pipe).

Carefully select a good pipe section and fully clean it, apply a wide band of coupling compound on each transducer face (bottom) and install the transducer properly.

Slowly and slightly move each transducer with respect to each other around the installation point until the maximum signal is detected. Be careful that the new installation location is free of scale inside the pipe and that the pipe is concentric (not distorted) so that the sound waves do not bounce outside of the proposed area.

For pipe with thick scale inside or outside, try to clean the scale off, if it is accessible from the inside. (Note: Sometimes this method might not work and sound wave transmission is not possible because of the a layer of scale between the transducers and pipe inside wall).

Question: Why is the CL output abnormal?

Answer: Check to see if the desired current output mode is set in Window M32-Mode. Check to see if the maximum and minimum current values are set properly in Windows M32-Range. Re-calibrate CL and verify it in Window M32-Check.

Question: Why is the flow rate still displayed as zero while there is fluid obviously inside the pipe and a symbol of "R" displayed on the screen?



Answer: Check to see if "Set Zero" was carried out with fluid flowing inside the pipe (Refer to Window M22).

If it is confirmed, recover the factory default in Window M22-Reset.

Appendix 1 – COMMUNICATIONS PROTOCOL

MODBUS-I COMMUNICATION PROTOCOL

This MODBUS-I Protocol uses RTU transmission mode. The Verification Code uses CRC-16-IBM (polynomial is $X^{16}+X^{15}+X^2+1$, shield character is 0xA001) which is gained by the cyclic redundancy algorithm method.

MODBUS-I RTU mode uses hexadecimals to transmit data.

1. MODBUS-I PROTOCOL FUNCTION CODE AND FORMAT

The flow meter protocol supports the following two-function codes of the MODBUS:

Function Code	Performance data
0x03	Read register
0x06	Write single register

2. MODBUS PROTOCOL FUNCTION CODE 0x03 USAGE

The host sends out the read register information frame format:

Slave Address	Operation Function Code	First Address Register	Register Number	Verify Code
1 byte	1 byte	2 bytes	2 bytes	2 bytes
0x01 ~ 0xF7	0x03	0x0000 ~ 0xFFFF	0x0000 ~ 0x7D	CRC (Verify)

The slave returns the data frame format:

Slave Address	Read Operation Function Code	Number of Data Bytes	Data Bytes	Verify Code
1 byte	1 byte	1 byte	N*x2 byte	2 bytes
0x01 ~ 0xF7	0x03	2xN*	N*x2 (Data)	CRC (Verify)

N* = Data register number

3. MODBUS PROTOCOL FUNCTION CODE 0x06 USAGE

The host sends a command to write a single register information frame format (function code 0x06):



Number CRC Verify Code Flow meter returned data is:
 0x01 0x06 0x10 0x03 0x00 0x02 0xFC 0xCB
 Flow meter Address Function Code Register Address Register Number CRC Verify
 Code
 Error Check

The flow meter only returns one error code 0x02 which means data first address in error.

For example, to read address 1 (0x01) of the flow meter 40002 register data in the RTU mode, the flow meter considers it to be invalid data, and sends the following command:

0x01 0x03 0x00 0x01 0x00 0x01 0xD5 0xCA

Flow meter Address Function Code Register Address Register Number

CRC Verify Code Flow meter returned error code is:

0x01 0x83 0x02 0xC0 0xF1

Flow meter Address Error Code Error Extended Code CRC Verify Code

MODBUS Register Address List

The flow meter MODBUS Register has a read register and a write single register.

a) Read Register Address List (use 0x03 function code to read)

PDU Address	Register	Read	Write	Type	No. registers*
\$0000	40001	Flow/s - low word	32 bits real	2	
\$0001	40002	Flow/s - high word			
\$0002	40003	Flow/m - low word	32 bits real	2	
\$0003	40004	Flow/m- high word			
\$0004	40005	Flow/h - low word	32 bits real	2	
\$0005	40006	Flow/h - high word			
\$0006	40007	Velocity – low word	32 bits real	2	
\$0007	40008	Velocity – high word			
\$0008	40009	Positive total – low word	32 bits int.	2	
\$0009	40010	Positive total – high word			



\$000A	40011	Positive total – exponent	16 bits int.	1	
\$000B	40012	Negative total – low word	32 bits int.	2	
\$000C	40013	Negative total – high word			
\$000D	40014	Negative total – exponent	16 bits int.	1	
\$000E	40015	Net total – low word	32 bits int.	2	
\$000F	40016	Net total – high word			
\$0010	40017	Net total – exponent	16 bits int.	1	
\$0011	40018	Energy flow – low word	32 bits int.	2	
\$0012	40019	Energy flow – high word			
\$0013	40020	Energy total(hot) –low word	32 bits real	2	
\$0014	40021	Energy total(hot) –high word			
\$0015	40022	Energy total(hot) – exponent	16 bits int.	1	
\$0016	40023	Energy total(cold) –high word	32 bits real	2	
\$0017	40024	Energy total(cold) – exponent			
\$0018	40025	Energy total(cold) – exponent	16 bits int.	1	
\$0019	40026	Up signal int – low word	32 bits real	2	0 ~ 99.9
\$001A	40027	Up signal int – high word			
\$001B	40028	Down signal int – low word	32 bits real	2	0 ~ 99.9
\$001C	40029	Down signal int – high word			
\$001D	40030	Quality	16 bits int.	1	0 ~ 99
\$001E	40031	Error code – char 1	String	1	Refer to "Error Analysis" for detailed codes meanings.



\$003B	40060	Flow velocity unit –char 1,2	String	2	Only m/s right now
\$003C	40061	Flow velocity unit –char 3,4			
\$003D	40062	Flow rate unit –char 1,2	String	2	Note 1
\$003E	40063	Flow rate unit –char 3,4			
\$003F	40064	Flow total unit – char 1,2	String	1	
\$0040	40065	Energy rate unit – char1,2	String	2	Note 2
\$0041	40066	Energy rate unit – char 3,4			
\$0042	40067	Energy total unit – char 1,2	String	1	
\$0043	40068	Instrument address –low word	32 bits real	2	
\$0044	40069	Instrument address –high word			
\$0045	40070	Serial number – char 1,2	String	4	
\$0046	40071	Serial number – char 3,4			
\$0047	40072	Serial number – char 5,6	String	4	
\$0048	40073	Serial number – char 7,8			
\$0049	40074	Analog Input AI1 Value- low word	32 bits real	2	Returned temperature value with RTD option
\$004a	40075	Analog Input AI1 Value- high word			
\$004b	40076	Analog Input AI2 Value- low word	32 bits real	2	
\$004c	40077	Analog Input AI2 Value- high word			
\$004d	40078	4-20mA Value- low word	32 bits real	2	Unit: mA
\$004e	40079	4-20mA Value- high word			

b) Single Write Register Address List (use 0x06 performance code to write)



PDU Address	Register	Description	Read/W rite	Type	No. registers*
-------------	----------	-------------	----------------	------	----------------

\$1003	44100	Flow meter address (1 - 255)	R/W	16 bits int.	1
\$1004	44101	Communication Baud Rate 0 = 2400,1 = 4800, 2 = 9600, 3 = 19200, 4 = 38400,5 = 56000	R/W	16 bits int.	1

Notes:

1. The following flow rate units are available:

0. "m3" - Cubic Meter
1. "l" - Liters
2. "ga" - Gallons
3. "ig" - Imperial Gallons
4. "mg" - Million Gallons
5. "cf" - Cubic Feet
6. "ba" - US Barrels
7. "ib" - Imperial Barrels
8. "ob" - Oil Barrels

2. The following energy units are available :

0. "GJ" - Giga Joule
1. "Kc" - Kilocalorie
2. "MB" - MBtu
3. "KJ" - Kilojoule
4. "Bt" - Btu
5. "Ts" - US Tonnes
6. "Tn" - US Tons
7. "kw" - Kwh

3. 16 bits int—short integer, 32 bits int – long integer, 32 bits real—floating point number,
S t r i n g — a l p h a b e t i c s t r i n g



Appendix 2 - Flow Application Data

Sound Velocity for Various Materials Commonly Used

Pipe Material	Sound Velocity (m/s)
Steel	3206
ABS	2286
Aluminum	3048
Brass	2270
Cast iron	2460
Bronze	2270
Fiber glass-epoxy	3430
Glass	3276
Polyethylene	1950
PVC	2540

Liner Material	Sound Velocity
Teflon	1225
Titanium	3150
Cement	4190
Bitumen	2540
Porcelain enamel	2540
Glass	5970
Plastic	2280
Polyethylene	1600
PTFE	1450
Rubber	1600



Appendix 3 : Sound Velocity in Water (1 atm) at different temperatures

t(°C)	v(m/s)	t(°C)	v(m/s)	t(°C)	v(m/s)
0	1402.3	34	1517.7	68	1554.3
1	1407.3	35	1519.7	69	1554.5
2	1412.2	36	1521.7	70	1554.7
3	1416.9	37	1523.5	71	1554.9
4	1421.6	38	1525.3	72	1555.0
5	1426.1	39	1527.1	73	1555.0
6	1430.5	40	1528.8	74	1555.1
7	1434.8	41	1530.4	75	1555.1
8	1439.1	42	1532.0	76	1555.0
9	1443.2	43	1533.5	77	1554.9
10	1447.2	44	1534.9	78	1554.8
11	1451.1	45	1536.3	79	1554.6
12	1454.9	46	1537.7	80	1554.4
13	1458.7	47	1538.9	81	1554.2
14	1462.3	48	1540.2	82	1553.9
15	1465.8	49	1541.3	83	1553.6
16	1469.3	50	1542.5	84	1553.2
17	1472.7	51	1543.5	85	1552.8
18	1476.0	52	1544.6	86	1552.4
19	1479.1	53	1545.5	87	1552.0
20	1482.3	54	1546.4	88	1551.5
21	1485.3	55	1547.3	89	1551.0
22	1488.2	56	1548.1	90	1550.4
23	1491.1	57	1548.9	91	1549.8
24	1493.9	58	1549.6	92	1549.2
25	1496.6	59	1550.3	93	1548.5
26	1499.2	60	1550.9	94	1547.5
27	1501.8	61	1551.5	95	1547.1
28	1504.3	62	1552.0	96	1546.3
29	1506.7	63	1552.5	97	1545.6
30	1509.0	64	1553.0	98	1544.7
31	1511.3	65	1553.4	99	1543.9
32	1513.5	66	1553.7		
33	1515.7	67	1554.0		

Refer to the sound velocity of other fluids and materials, please contact the factor



MIAL[®]
INSTRUMENTS PVT.LTD.
Measuring & Beyond

USA OFFICE ADDRESS

MIAL INSTRUMENTS PVT. LTD.
Downtown Republic Center
325 N. St.Paul Street, Suite 3100
Dallas 75201, Texas, USA

FACTORY ADDRESS

MIAL INSTRUMENTS PVT. LTD.
856/ 6 GIDC
Makarpura, Vadodara 390010, Gujarat, India
+91-9913449547/9913449548

Email : info@mialinstruments.com
www.mialinstruments.com



**MIAL
INSTRUMENTS**
Measuring & Beyond

856/6, GIDC MAKARPURA, VADODARA - 390010
Phone : +91-9913449547 / +91-9913449548
E-MAIL : info@mialinstruments.com
WWW : www.mialinstruments.com